

**POLARIS**<sup>®</sup>  
The Way Out.



# **Sportsman<sup>®</sup> 500 HO**

## **Owner's Manual for Maintenance and Safety**

Read this manual carefully. It contains important safety information.  
This is an adult vehicle only.  
Operation is prohibited for those under 16 years of age.

**⚠ WARNING**

The engine exhaust from this product contains chemicals known to the State of California to cause cancer, birth defects or other reproductive harm.

A card containing important ATV safety information should be attached to the owner's manual on the next page. If you cannot locate this card, or if it has been removed, please call 1-800-342-3764 for assistance.



The text is printed on 100% recycled  
with 40% post-consumer waste (PCW).

# ⚠️ WARNING

Improper vehicle use can result in **SEVERE INJURY** or **DEATH**.



**ALWAYS USE  
AN APPROVED  
HELMET AND  
PROTECTIVE  
GEAR**



**NEVER USE  
ON PUBLIC  
ROADS**



**NEVER CARRY  
PASSENGERS**



**NEVER USE  
WITH DRUGS  
OR ALCOHOL**

## **NEVER** operate:

- without proper training or instruction.
- at speeds too fast for your skills or the conditions.
- on public roads - a collision can occur with another vehicle.
- with a passenger - passengers affect balance and steering and increase risk of losing control.

## **ALWAYS:**

- use proper riding techniques to avoid vehicle overturns on hills and rough terrain and in turns.
- avoid paved surfaces - pavement may seriously affect handling and control.

**READ OWNER'S MANUAL.**

**FOLLOW ALL INSTRUCTIONS AND WARNINGS.**



**POLARIS**  
The Way Out.®

For your nearest Polaris dealer,  
call 1-800-POLARIS  
or visit [www.polarisindustries.com](http://www.polarisindustries.com)  
Polaris Sales Inc., 2100 Hwy 55  
Medina, MN 55340  
Phone 1-888-704-5290  
Part No. 9922247 Rev 01  
Printed in USA

# WELCOME

Thank you for purchasing a Polaris vehicle, and welcome to our world-wide family of Polaris owners. We proudly produce an exciting line of utility and recreational products.

- Snowmobiles
- All-terrain vehicles (ATVs)
- *RANGER*® utility vehicles
- Victory Motorcycles®

We believe Polaris sets a standard of excellence for all utility and recreational vehicles manufactured in the world today. Many years of experience have gone into the engineering, design, and development of your Polaris vehicle, making it the finest machine we've ever produced.

For safe and enjoyable operation of your vehicle, be sure to follow the instructions and recommendations in this owner's manual. Your manual contains instructions for minor maintenance, but information about major repairs is outlined in the Polaris Service Manual and should be performed only by a factory certified Master Service Dealer® (MSD) technician.

Your Polaris dealer knows your vehicle best and is interested in your total satisfaction. Be sure to return to your dealership for all of your service needs during, and after, the warranty period.

We also take great pride in our complete line of apparel, parts and accessories, available through our online store at [www.purepolaris.com](http://www.purepolaris.com). Have your accessories and clothing delivered right to your door!



**POLARIS**®  
The Way Out.

POLARIS, THE WAY OUT and SPORTSMAN are registered trademarks of Polaris Industries Inc.

Copyright 2009 Polaris Sales Inc. All information contained within this publication is based on the latest product information at the time of publication. Due to constant improvements in the design and quality of production components, some minor discrepancies may result between the actual vehicle and the information presented in this publication. Depictions and/or procedures in this publication are intended for reference use only. No liability can be accepted for omissions or inaccuracies. Any reprinting or reuse of the depictions and/or procedures contained within, whether whole or in part, is expressly prohibited.

Printed in U.S.A.

2010 Sportsman 500 HO Owner's Manual

P/N 9922247

# TABLE OF CONTENTS

<b>Introduction</b> . . . . .	<b>4</b>
<b>Safety</b> . . . . .	<b>7</b>
<b>Features and Controls</b> . . . . .	<b>24</b>
<b>Operation</b> . . . . .	<b>41</b>
<b>Emission Control Systems</b> . . . . .	<b>61</b>
<b>Maintenance</b> . . . . .	<b>62</b>
<b>Troubleshooting</b> . . . . .	<b>113</b>
<b>Polaris Products</b> . . . . .	<b>117</b>
<b>Specifications</b> . . . . .	<b>118</b>
<b>Declaration of Conformity</b> . . . . .	<b>120</b>
<b>Warranty</b> . . . . .	<b>121</b>
<b>Maintenance Log</b> . . . . .	<b>129</b>
<b>Index</b> . . . . .	<b>131</b>

# INTRODUCTION

The following signal words and symbols appear throughout this manual and on your vehicle. Your safety is involved when these words and symbols are used. Become familiar with their meanings before reading the manual.



The safety alert symbol indicates a potential personal injury hazard.

## **WARNING**

A **WARNING** indicates a hazardous situation which, if not avoided, may result in death or serious injury.

## **CAUTION**

A **CAUTION** indicates a hazardous situation which, if not avoided, may result in minor or moderate injury.

## **NOTICE**

A **NOTICE** indicates a situation that may result in property damage.



The Prohibition Safety Sign indicates an action **NOT** to take in order to avoid a hazard.



The Mandatory Action Sign indicates an action that **NEEDS** to be taken to avoid a hazard.



# INTRODUCTION

## **WARNING**

Failure to heed the warnings and safety precautions contained in this manual can result in severe injury or death. A Polaris ATV is not a toy and can be hazardous to operate. This vehicle handles differently than other vehicles, such as motorcycles and cars. A collision or rollover can occur quickly, even during routine maneuvers like turning, or driving on hills or over obstacles, if you fail to take proper precautions.

- Read this owner's manual. Understand all safety warnings, precautions and operating procedures before operating a Polaris ATV. Keep this manual with the ATV.
- Never operate an ATV without proper instruction. Take a training course.
- This vehicle is an **ADULT VEHICLE ONLY**. Operation is prohibited for anyone under 16 years of age.
- Never permit a guest to operate the ATV unless the guest has read this manual and all product labels and has completed a certified safety training course.

# INTRODUCTION

## Vehicle Identification Numbers

Record your vehicle's identification numbers and key number in the spaces provided. Remove the spare key and store it in a safe place. An ignition key can be duplicated only by ordering a Polaris key blank (using your key number) and mating it with one of your existing keys. The ignition switch must be replaced if all keys are lost.

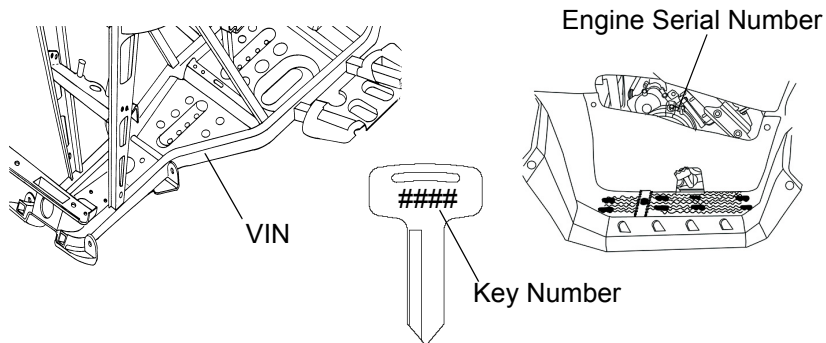

Vehicle Model Number: \_\_\_\_\_

Frame VIN: \_\_\_\_\_

Engine Serial Number: \_\_\_\_\_

Key Number: \_\_\_\_\_

## Safety Training

ATV safety training is a top priority for Polaris. Polaris strongly encourages you and any family members who will be riding the ATV to take a training course.

If you purchased a new Polaris ATV in the United States, your dealer provided instruction to you about the authorized ATV *RiderCourse*<sup>sm</sup> that is available to you and your eligible family members. This training is included in the purchase price of your ATV. You were also provided with printed materials that explain safe operating procedures. You should review this information on a regular basis.

If you purchased a used Polaris ATV in the United States, you can enroll in the *ATV RiderCourse*<sup>sm</sup> for a fee. Call ATV Enrollment Express at (800) 887-2887 or visit [www.atvsafety.org](http://www.atvsafety.org).

If you purchased a Polaris ATV outside the United States, please contact your dealer or local law enforcement agencies for information about safety training.

A Polaris ATV is an off-road vehicle. Familiarize yourself with all laws and regulations concerning the operation of this vehicle in your area.

We strongly advise you to strictly follow the recommended maintenance program outlined in your owner's manual. This preventive maintenance program is designed to ensure that all critical components on your vehicle are thoroughly inspected at specific intervals.

**FOR MORE INFORMATION ABOUT ATV SAFETY in the United States, call the Consumer Product Safety Commission at 1-800-638-2772, or visit [www.cpsc.gov](http://www.cpsc.gov), visit [www.atvsafety.org](http://www.atvsafety.org), or call Polaris at 1-800-342-3764.**

# SAFETY

## Safe Riding Gear

Always wear appropriate clothing when riding an ATV. Wear protective clothing for comfort and to reduce the chance of injury.

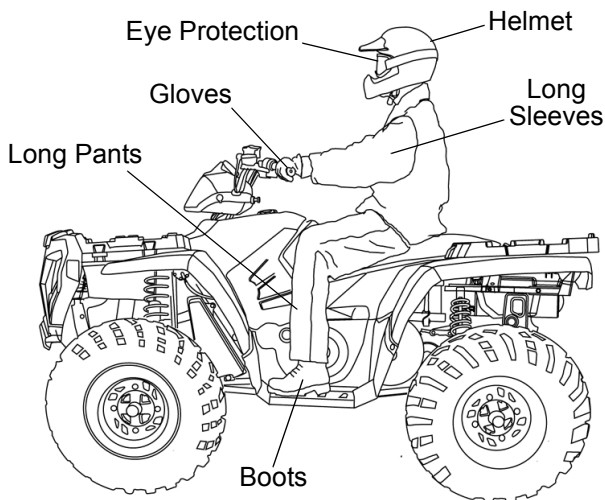

### Helmet

Wearing a helmet can prevent a severe head injury. Whenever riding a Polaris vehicle, always wear a helmet that meets or exceeds established safety standards.

Approved helmets in the USA and Canada bear a U.S. Department of Transportation (DOT) label.

Approved helmets in Europe, Asia and Oceania bear the ECE 22.05 label. The ECE mark consists of a circle surrounding the letter E, followed by the distinguishing number of the country which has granted approval. The approval number and serial number will also be displayed on the label.

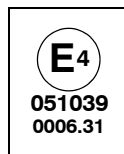

## Safe Riding Gear

### Eye Protection

Do not depend on eyeglasses or sunglasses for eye protection. Whenever riding a Polaris vehicle, always wear shatterproof goggles or use a shatterproof helmet face shield. Polaris recommends wearing approved Personal Protective Equipment (PPE) bearing markings such as VESC 8, V-8, Z87.1, or CE. Make sure protective eye wear is kept clean.

### Gloves

Off-road style gloves with knuckle pads are the best for comfort and protection.

### Boots

The best footwear is a pair of sturdy over-the-calf boots with low heels.

### Clothing

Always wear long sleeves and long pants to protect arms and legs. Riding pants with kneepads and a jersey with shoulder pads provide the best protection.

## Equipment Modifications

We strongly recommend that consumers do not install on a Polaris ATV any equipment that may increase the speed or power of the vehicle, or make any other modifications to the vehicle for these purposes.

The warranty on your Polaris ATV is terminated if any equipment has been added to the vehicle, or if any modifications have been made to the vehicle, that increase its speed or power.

The addition of certain accessories, including (but not limited to) mowers, blades, tires, sprayers, or large racks, may change the handling characteristics of the vehicle. Use only Polaris-approved accessories, and familiarize yourself with their function and effect on the vehicle.

# SAFETY

## Safety Warnings

### **⚠ WARNING**

Failure to operate the ATV properly can result in a collision, loss of control, accident or overturn, which may result in serious injury or death. Heed all safety warnings outlined in this section of the owner's manual. See the OPERATION section of the owner's manual for proper operating procedures.

### **Operating Without Instruction**

Operating this ATV without proper instruction increases the risk of an accident. The operator must understand how to operate the ATV properly in different situations and on different types of terrain.

Beginning and inexperienced operators should complete the recommended safety training before operating this vehicle. See page 7.

Never permit a guest to operate the ATV unless the guest has read this manual and all product labels and has completed a certified safety training course.

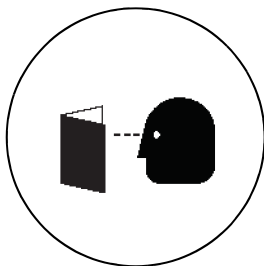

### **Age Restrictions**

This vehicle is an **ADULT VEHICLE ONLY**. Operation is prohibited for anyone under 16 years of age.

Even though a child may be within the recommended age group for operating some ATVs, he/she may not have the skills, abilities, or judgment needed to operate an ATV safely and could be susceptible to accident or injury.



## Safety Warnings

### Handling Gasoline

Gasoline is highly flammable and explosive under certain conditions.

- Always exercise extreme caution whenever handling gasoline.
- Always refuel with the engine stopped, and outdoors or in a well ventilated area.
- Do not smoke or allow open flames or sparks in or near the area where refueling is performed or where gasoline is stored.
- Do not overfill the tank. Do not fill the tank neck.
- If gasoline spills on your skin or clothing, immediately wash it off with soap and water and change clothing.
- Turn the fuel valve off whenever the vehicle is stored or parked.

### Exposure to Exhaust

Engine exhaust fumes are poisonous and can cause loss of consciousness or death in a short time. Never start the engine or let it run in an enclosed area.

The engine exhaust from this product contains chemicals known to cause cancer, birth defects or other reproductive harm. Operate this vehicle only outdoors or in well-ventilated areas.

### Failure to Inspect Before Operating

Failure to inspect and verify that the ATV is in safe operating condition before operating increases the risk of an accident.

Always inspect the ATV before each use to make sure it's in safe operating condition.

Always follow all inspection and maintenance procedures and schedules described in the owner's manual.

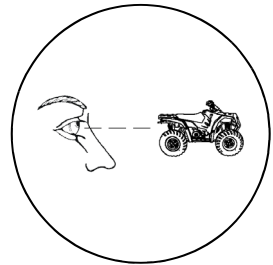

# SAFETY

## Safety Warnings

### Protective Apparel

Riding in this vehicle without wearing an approved helmet and protective eyewear increases the risk of a serious injuries in the event of an accident.

Operator and passenger must always wear an approved helmet that fits properly and eye protection (goggles or face shield).

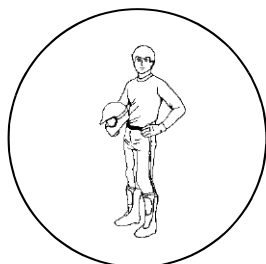

### Using Alcohol or Drugs

Operating the ATV after consuming alcohol or drugs could adversely affect operator judgment, reaction time, balance and perception.

Never consume alcohol or drugs before or while operating an ATV.



### Carrying a Passenger

Carrying a passenger greatly reduces the operator's ability to balance and control the ATV, which may result in an accident or overturn.

Never carry a passenger on this ATV.





## Safety Warnings

### Operating on Pavement

Operating an ATV on paved surfaces (including sidewalks, paths, parking lots and driveways) may adversely affect the handling of the ATV and could result in loss of control and accident or overturn.

Avoid operating the ATV on pavement. ATV tires are designed for off-road use. If it's unavoidable, travel slowly and avoid sudden turns or stops.

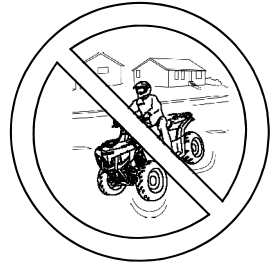

### Operating on Public Roads

Operating this ATV on public streets, roads or highways could result in a collision with another vehicle.

Never operate the ATV on any public street, road or highway, including dirt and gravel roads. In many states it's unlawful to operate ATVs on public streets, roads and highways.



### Operating at Excessive Speeds

Operating the ATV at excessive speeds increases the operator's risk of losing control.

Always operate at a speed that's appropriate for the terrain, the visibility and operating conditions, and your experience.

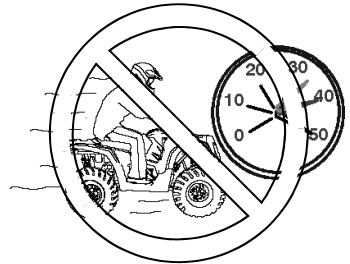

# SAFETY

## Safety Warnings

### Physical Control of the ATV

Removing a hand from the handlebars or feet from the footrests during operation can reduce your ability to control the vehicle or cause loss of balance and ejection from the ATV. If the operator's foot is not firmly planted on the footrest, it could also contact the rear wheels.

Never remove your hands from the handlebars while operating, and always keep both feet on the footrests.



### Turning Improperly

Turning improperly could cause loss of traction, loss of control, accident or overturn.

Always follow proper procedures for turning as described in the owner's manual.

Never turn abruptly or at sharp angles. Never turn at high speeds. Practice turning at slow speeds before attempting to turn at faster speeds.



### Jumps and Stunts

Attempting wheelies, jumps and other stunts increases the risk of an accident or overturn.

Never attempt wheelies, jumps, or other stunts. Avoid exhibition driving.

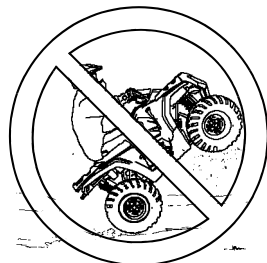

### Improper Hill Climbing

Improper hill climbing could cause loss of control or overturn. Always follow proper procedures for climbing hills as described in the owner's manual. See page 51.

## Safety Warnings

### Descending Hills Improperly

Improperly descending a hill could cause loss of control or overturn.

- Always follow proper procedures for traveling down hills as described in the owner's manual. **NOTE:** A special technique is required when braking while traveling downhill. See page 53.
- Always descend a hill with the transmission in forward gear. Do not descend a hill with the transmission in neutral.
- Always check the terrain carefully before descending a hill.
- Shift your weight rearward.
- Never travel down a hill at high speed.
- Avoid traveling down a hill at an angle, which would cause the vehicle to lean sharply to one side. Travel straight down the hill when possible.



### Crossing Hillside

Driving on a sidehill is not recommended. Improper procedure could cause loss of control or overturn. Avoid crossing the side of any hill unless absolutely necessary.

If crossing a hillside is unavoidable, always follow proper procedures as described in the owner's manual. See page 52.

Never attempt to turn the ATV around on any hill until you've mastered the turning technique (on level ground) as described in the owner's manual. See page 54.



# SAFETY

## Safety Warnings

### Stalling While Climbing a Hill

Stalling, rolling backwards or improperly dismounting while climbing a hill could cause an overturn.

- Always maintain a steady speed when climbing a hill.

If all forward speed is lost:

- Keep body weight uphill.
- Apply the brakes.
- Lock the parking brake when fully stopped.
- Dismount on uphill side, or to either side if ATV is pointed straight uphill.
- Turn the ATV around and remount, following the procedure described in the owner's manual. See page 54.

If the ATV begins rolling downhill:

- Keep body weight uphill.
- Never apply engine power.
- Never apply the rear brake while rolling backwards. Apply the single-lever brake gradually.
- When fully stopped, apply the rear brake as well, and then lock the parking brake.
- Dismount on uphill side, or to either side if ATV is pointed straight uphill.
- Turn the ATV around and remount, following the procedure described in the owner's manual. See page 54.



### Operating on Steep Hills

Operating on excessively steep hills could cause an overturn.

Never operate on hills too steep for the ATV or for your abilities. Never operate the ATV on hills steeper than 25 degrees.



## Safety Warnings

### Operating on Slippery Terrain

Failure to use extra caution when operating on excessively rough, slippery or loose terrain could cause loss of traction, loss of control, accident or overturn.

Do not operate on excessively rough, slippery or loose terrain. Always use extra caution on rough, slippery or loose terrain.

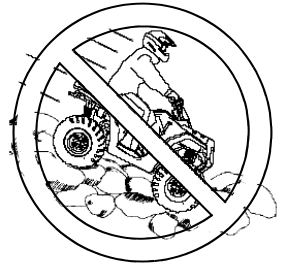

### Operating in Unfamiliar Terrain

Failure to use extra caution when operating on unfamiliar terrain could result in an accident or overturn.

Unfamiliar terrain may contain hidden rocks, bumps, or holes that could cause loss of control or overturn.

Travel slowly and use extra caution when operating on unfamiliar terrain. Always be alert to changing terrain conditions.



# SAFETY

## Safety Warnings

### Operating Improperly in Reverse

Improperly operating in reverse could result in a collision with an obstacle or person. Always follow proper operating procedures as outlined in this manual. See page 57.

Before shifting into reverse gear, always check for obstacles or people behind the ATV. When it's safe to proceed, back slowly.

### Improper Tire Maintenance

Operating this ATV with improper tires or with improper or uneven tire pressure could cause loss of control or accident.

Always use the size and type of tires specified for your ATV.

Always maintain proper tire pressure as described in the owner's manual and on safety labels.

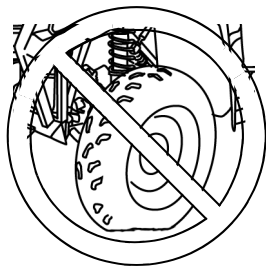

### Operating Over Obstacles

Improperly operating over obstacles could cause loss of control or overturn.

Before operating in a new area, check for obstacles. Avoid operating over large obstacles such as rocks and fallen trees. If unavoidable, use extreme caution and always follow proper operating procedures as outlined in this manual. See page 57.

### Skidding or Sliding

Skidding or sliding can cause loss of control or overturn (if tires regain traction unexpectedly).

On slippery surfaces such as ice or loose gravel, travel slowly and use extra caution to reduce the chance of skidding or sliding. Do not operate on excessively slippery surfaces.

## Safety Warnings

### Operating Through Deep Water

Operating the ATV through deep or fast-flowing water could cause the tires to float, causing loss of control or overturn.

Avoid operating the ATV through deep or fast-flowing water. If it's unavoidable to enter water that exceeds the recommended maximum depth (see page 55):

- Travel slowly.
- Balance your weight carefully.
- Avoid sudden movements.
- Maintain a slow and steady forward motion. Do not make sudden turns or stops, and do not make sudden throttle changes.
- Wet brakes may have reduced stopping ability. After leaving water, test the brakes. Apply them lightly several times while driving slowly. The friction will help dry out the pads.



### Improper Cargo Loading

Overloading the ATV or carrying/towing cargo improperly may cause changes in handling, which could cause loss of control or an accident.

- Never exceed the stated load capacity for this ATV.
- Cargo should be properly distributed and securely attached.
- Reduce speed when carrying cargo or pulling a trailer. Allow a greater distance for braking.
- Always follow the instructions in the owner's manual for carrying cargo or pulling a trailer.

# **SAFETY**

## **Safety Warnings**

### **Operating on Frozen Bodies of Water**

Operating on frozen bodies of water may result in serious injury or death if the ATV and/or the operator fall through the ice.

Never operate the ATV on a frozen body of water.

### **Poor Visibility**

Operating the ATV in darkness or inclement weather could result in a collision or accident, especially if operating on a road or street. This ATV is not equipped with highway-approved lights. Operate this vehicle off-road only. Use caution and drive at reduced speeds in conditions of reduced visibility such as fog, rain and darkness. Clean headlights frequently and replace burned out headlamps promptly.

### **Operating a Damaged ATV**

Operating a damaged ATV can result in an accident. After any overturn or accident, have a qualified service dealer inspect the entire machine for possible damage, including (but not limited to) brakes, throttle and steering systems.

### **Physical Skills**

Safe operation of this rider-active vehicle requires good judgement and physical skills. Persons with cognitive or physical disabilities who operate this vehicle have an increased risk of overturn and loss of control.

### **Hot Exhaust Systems**

Exhaust system components are very hot during and after use of the vehicle. Hot components can cause burns and fire. Do not touch hot exhaust system components. Always keep combustible materials away from the exhaust system. Use caution when traveling through tall grass, especially dry grass.

### **Unauthorized Use of the ATV**

Leaving the keys in the ignition can lead to unauthorized use of the vehicle, which could result in an accident or overturn. Always remove the ignition key when the vehicle is not in use.



## Safety Decals and Locations

Warning labels have been placed on the vehicle for your protection. Read and follow the instructions on each label carefully. If any of the labels shown in this manual differ from the labels on your vehicle, always read and follow the instructions of the labels on the vehicle.

If an informational or graphic label becomes illegible or comes off, contact your Polaris dealer to purchase a replacement. Replacement *safety* labels are provided by Polaris at no charge. The part number is printed on the label.

### General Warning/Discretionary Warning

#### WARNING

Improper ATV use can result in SEVERE INJURY or DEATH  
ALWAYS USE AN APPROVED HELMET AND PROTECTIVE GEAR  
NEVER USE ON PUBLIC ROADS  
NEVER CARRY PASSENGERS  
NEVER USE WITH DRUGS OR ALCOHOL

#### **NEVER** operate:

- without proper training or instruction
- at speeds too fast for your skills or the conditions
- on public roads - a collision can occur with another vehicle
- with a passenger - passengers affect balance and steering and increase risk of losing control

#### **ALWAYS:**

- use proper riding techniques to avoid vehicle overturns on hills and rough terrain and in turns
- avoid paved surfaces - pavement may seriously affect handling and control

LOCATE AND READ OPERATOR'S MANUAL.

FOLLOW ALL INSTRUCTIONS AND WARNINGS.

#### WARNING

- Never operate this ATV on HILLS steeper than 25 degrees  $\leq 25^\circ$ . To prevent overturn on hilly terrain, use throttle and brakes gradually, and shift weight uphill.
- REVERSE operation can be dangerous even at low speeds. Steering becomes difficult. To prevent loss of control, avoid sudden braking or sharp turns.

7175550

# SAFETY

## Safety Decals and Locations

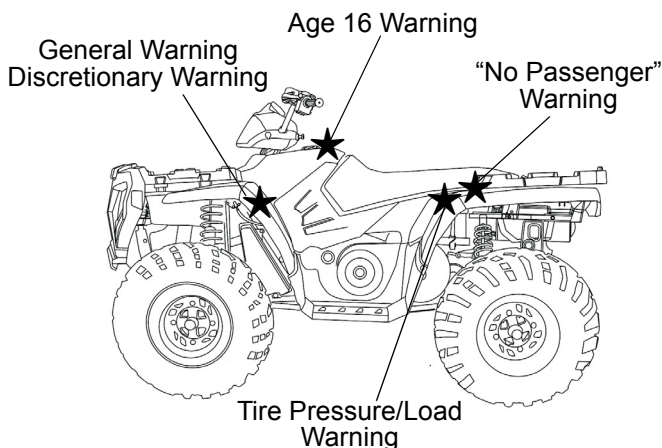

### Tire Pressure/Load Warning

#### WARNING

Improper tire pressure or overloading can cause loss of control. Loss of control can result in severe injury or death.

- Cold tire pressure:
  - Front: 5.0 psi (34.5 kPa)
  - Rear: 5.0 psi (34.5 kPa)
- Maximum weight capacity: 485 lbs. (220 kg)

7175642

### “No Passenger” Warning

#### WARNING

NEVER ride as a passenger.

Passengers can cause a loss of control, resulting in SEVERE INJURY or DEATH.

7175378

### Age 16 Warning

#### WARNING

Operating this ATV if you are under the age of 16 increases your chance of severe injury or death.

NEVER operate this ATV if you are under age 16.

7175551

## Safety Decals and Locations

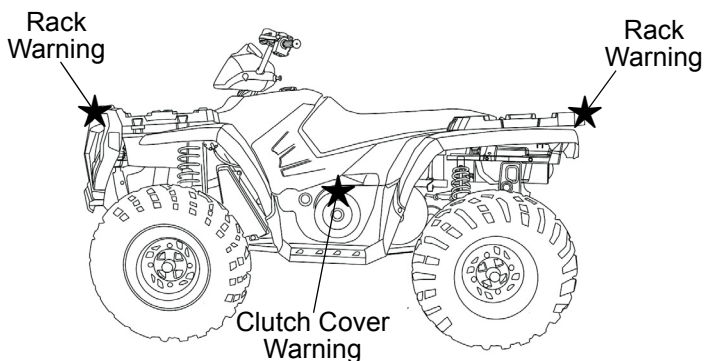

### Clutch Cover Warning

#### WARNING

- Moving parts hazard under belt-clutch guard. To prevent serious injury, do not operate vehicle with guard removed.
- Do not modify engine or clutch. Doing so can cause part failure, possible imbalance, and excessive engine RPM, which can result in serious injury or death.

#### NO STEP

7172563

### Rack Warning, Front and Rear

#### WARNING

- DO NOT TOW FROM RACK OR BUMPER. Vehicle damage or tipover may result causing severe injury or death. Tow only from tow hooks or hitch.
- Max Rack Loads: Front 90 lbs. (41 kg) Rear 180 lbs. (82 kg)

7172572

### Reverse Override Warning/4X4 Caution

#### WARNING

Improper use of override button can lead to loss of control resulting in serious injury or death. Do not activate override while throttle is engaged. Always apply throttle gradually while in reverse.

#### CAUTION

Do not push switch to engage 4X4 (AWD) if the rear wheels are spinning. This may cause severe drive shaft and clutch damage.

7175552

# FEATURES AND CONTROLS

## Switches

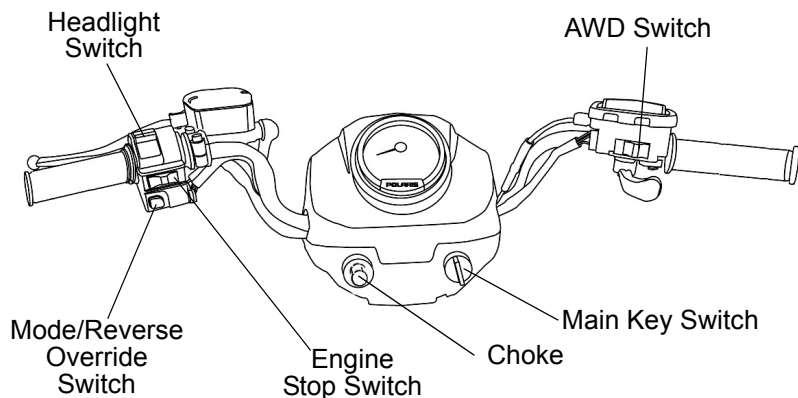

### Mode/Reverse Override Switch

This vehicle is equipped with a reverse speed limiter system. To gain additional wheel speed while backing, release the throttle and depress the override button.

**WARNING!** Pressing the override button while the throttle is open can cause loss of control, which may result in serious injury or death. Always release the throttle before pressing the override button.

The override switch also allows activation of 4X4 in reverse, if the 4X4 switch is on. This switch is also used to toggle through the modes of the rider information center. See page 34.

### AWD Switch

Use the AWD switch to engage 4X4 or 2X4. See page 33.

# FEATURES AND CONTROLS

## Switches

### Engine Stop Switch

Move the stop switch either left or right to the OFF position to stop the engine quickly. The engine will not start or run when the switch is off.

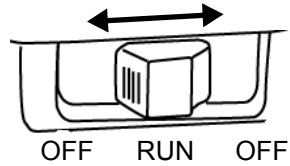

Both the main switch and the engine stop switch will shut off all electrical power to the vehicle, including lights.

### Main Key Switch

Use the main key switch to start the engine. See page 46 for starting procedures.

### Headlight Switch

Use the headlight switch to turn the lights on and off and to change the lights from high beam to low beam. The key must be in the ON position and the engine stop switch must be in the RUN position to operate the headlights.

# FEATURES AND CONTROLS

## Throttle Lever

### **⚠ WARNING**

Operating an ATV with sticking or improperly operating throttle controls could cause an accident. Never start or operate an ATV that has a sticking or improperly operating throttle. Always contact your dealer for service before operating the vehicle.

Failure to check or maintain proper operation of the throttle system can result in an accident if the throttle lever sticks during operation. Always check the lever for free movement and return before starting the engine. Also check occasionally during operation.

Modifications to the electronic throttle control could result in failure to perform as designed, which could result in an accident. Do not attempt to modify the throttle control system or replace it with any after market throttle mechanisms. Always ensure that the throttle cable is installed and properly routed to the throttle control.

Engine speed and vehicle movement are controlled by pressing the throttle lever. The throttle lever is spring loaded. Engine speed returns to idle when the lever is released.

This ATV is equipped with Polaris Electronic Throttle Control (ETC), which is designed to reduce the risk of a frozen or stuck throttle. If the throttle cable should stick in an

open position when the operator releases the throttle lever, the engine will stop, and power to the rear wheels will cease.

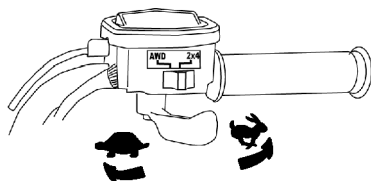

# FEATURES AND CONTROLS

## Brake Lever

### **⚠ WARNING**

Operating the ATV with a spongy brake lever can result in loss of braking, which could cause an accident. Never operate the ATV with a spongy-feeling brake lever. Always contact your dealer for service before operating the vehicle.

Squeeze the brake lever toward the handlebar to apply the front and rear brakes. These brakes are hydraulically activated disc type brakes that are activated by only one lever.

Always test brake lever travel and master cylinder fluid level before riding. When squeezed, the lever should feel firm. Any sponginess would indicate a possible fluid leak or low master cylinder fluid level, which must be corrected before riding. Contact your dealer for proper diagnosis and repairs.

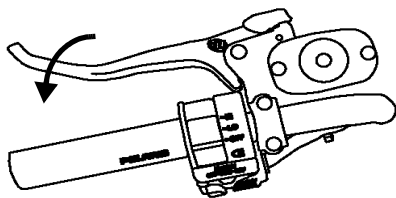

# FEATURES AND CONTROLS

## Master Cylinder/Brake Fluid

### **⚠ WARNING**

An over-full master cylinder may cause brake drag or brake lock-up, which could result in an accident. Maintain brake fluid at the recommended level. Do not overfill.

Never store or use a partial bottle of brake fluid. Brake fluid is hygroscopic, meaning it rapidly absorbs moisture from the air. The moisture causes the boiling temperature of the brake fluid to drop, which can lead to early brake fade and the possibility of brake failure, which could result in an accident. After opening a bottle of brake fluid, always discard any unused portion.

Check the brake fluid in the master cylinder before each ride.

1. Position the ATV on a level surface.
2. Position the handlebars so the master cylinder is level.
3. View the brake fluid level through the indicator window on the top of the master cylinder. The eye will appear dark when the fluid level is full. When fluid is low, the eye will be clear.
4. If the fluid level is low add DOT 4 brake fluid only. Do not overfill.

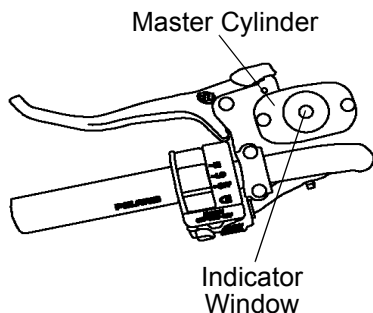



# FEATURES AND CONTROLS

## Parking Brake

### Locking the Parking Brake

1. Place the transmission in PARK.
2. Squeeze and release the brake lever two or three times, then squeeze and hold.
3. Push the parking brake lock forward to engage the lock.
4. Release the brake lever.
5. To release the parking brake lock, squeeze and release the brake lever. It will return to its unlocked position.

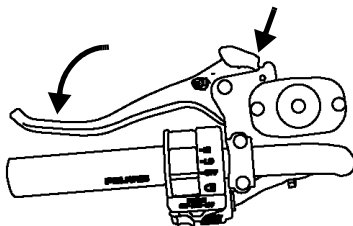

**WARNING!** Operating the ATV while the parking brake is engaged could result in an accident or fire. Always check to be sure the parking brake is disengaged before operating.

The parking brake may relax if left on for a long period of time. Always block the wheels to prevent rolling. Always block the wheels on the downhill side of the ATV if leaving it parked on a hill. Another option is to park the ATV in a sidehill position. Never depend on the parking brake alone if the ATV is parked on a hill. Always block the wheels to prevent rolling.

# FEATURES AND CONTROLS

## Auxiliary Foot Brake

### **⚠ WARNING**

Aggressively applying the auxiliary brake when backing down a hill may cause rear tipover, which could result in serious injury or death. Never back down a hill.

Use caution when applying the auxiliary brake. Do not aggressively apply the auxiliary brake when going forward. The rear wheels may skid and slide sideways, causing loss of control, which may result in serious injury or death.

The auxiliary brake system is intended to be used as a backup for the main brake system. Should the main system fail, use the auxiliary foot brake. Since this is a rear brake only, it will not be as effective as the all-wheel single lever system.

The auxiliary foot brake is located on the inside of the right footrest. Operate this brake with your right foot.

If the rear wheels slide while using the auxiliary brake, *reduce* brake pedal pressure to brake the rear wheels without skidding.

### **Brake Fluid Level**

Check the brake fluid level frequently for the auxiliary brake system. The reservoir is located near the auxiliary brake. Maintain the fluid level between the maximum and minimum marks.

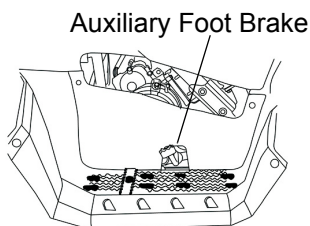

# FEATURES AND CONTROLS

## Choke

The choke assists in starting a cold engine. Refer to the engine starting procedure on page 46 for correct choke and throttle settings during starting.

## Fuel Valve

The fuel valve is located under the front storage box cover.

OFF: For vehicle storage and when transporting.

ON: For normal operation.

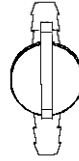

ON

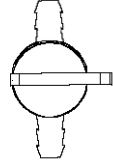

OFF

## Fuel Tank Cap

This vehicle is equipped with a digital fuel gauge that will indicate a low fuel condition. Refuel when the gauge indicates a low fuel condition.

Always refuel with the engine stopped, and outdoors or in a well ventilated area. Refuel on a level surface.

Remove the fuel tank cap to add fuel to the fuel tank. Use either leaded or unleaded gasoline with a minimum pump octane number of  $87 = (R + M/2)$  octane. *Do not use fuel with ethanol content greater than 10 percent, such as E-85 fuel.*

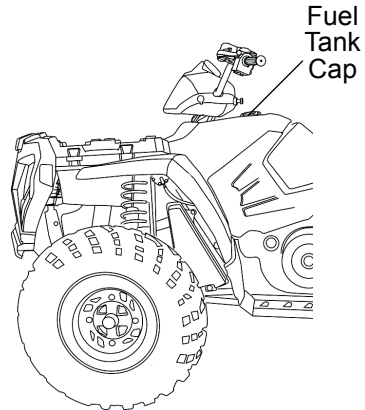

## Fuel Filter

The in-line fuel filter should be replaced by your dealer after every 100 hours of operation, or annually. Do not attempt to clean the fuel filter.

# FEATURES AND CONTROLS

## Automatic Transmission Gear Selector

The transmission gear selector is located on the right side of the vehicle.

H: High Gear

L: Low Gear

N: Neutral

R: Reverse

P: Park

To shift gears, brake to a complete stop. When the engine is idling, move the lever to the desired gear.

**NOTICE:** Shifting gears with the engine speed above idle or while the vehicle is moving could cause transmission damage.

Whenever the ATV is left unattended, always place the transmission in PARK and lock the parking brake.

### Belt Life

To extend belt life, use low forward gear in heavy pulling situations and when operating at less than seven miles per hour for extended periods of time.

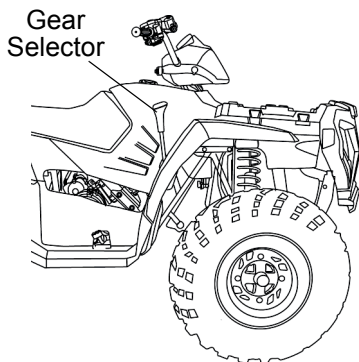

# FEATURES AND CONTROLS

## All Wheel Drive (AWD) System

The All Wheel Drive system is controlled by the AWD switch. When the switch is on 2X4, the ATV is in two-wheel drive at all times. When the switch is on AWD, the ATV is in all wheel drive and the AWD indicator light in the instrument cluster will be on.

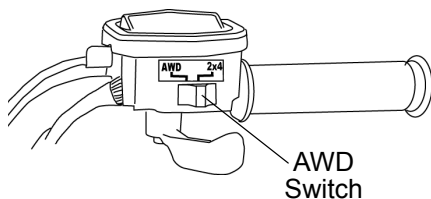

When in AWD, the demand drive unit will automatically engage any time the rear wheels lose traction. When the rear wheels regain traction, the demand drive unit will automatically disengage.

**Tip:** The override switch allows activation of AWD in reverse if the AWD switch is on. See page 24.

There is no limit to the length of time the vehicle may remain in AWD.

### Engaging AWD

The AWD switch may be turned on or off while the vehicle is moving. Initially, the vehicle's electronic system will not enable the AWD until the engine RPM is below 3100. Once enabled, the AWD remains enabled until the AWD switch is turned off. If the switch is turned off while the demand drive unit is moving, it will not disengage until the rear wheels regain traction.

Engage the AWD switch before getting into conditions where front wheel drive may be needed. If the rear wheels are spinning, release the throttle before switching to AWD.

# FEATURES AND CONTROLS

## Instrument Cluster

Your ATV is equipped with an instrument cluster that senses vehicle speed from the right front wheel. In addition to showing vehicle speed, the speedometer needle flashes when a warning condition exists.

The instrument cluster measures distance in miles as well as hours of operation. It also includes a reverse speed limiter function that limits the ATV's speed to approximately 7-9 mph (11-14 km/h). Refer to page 24 for additional information.

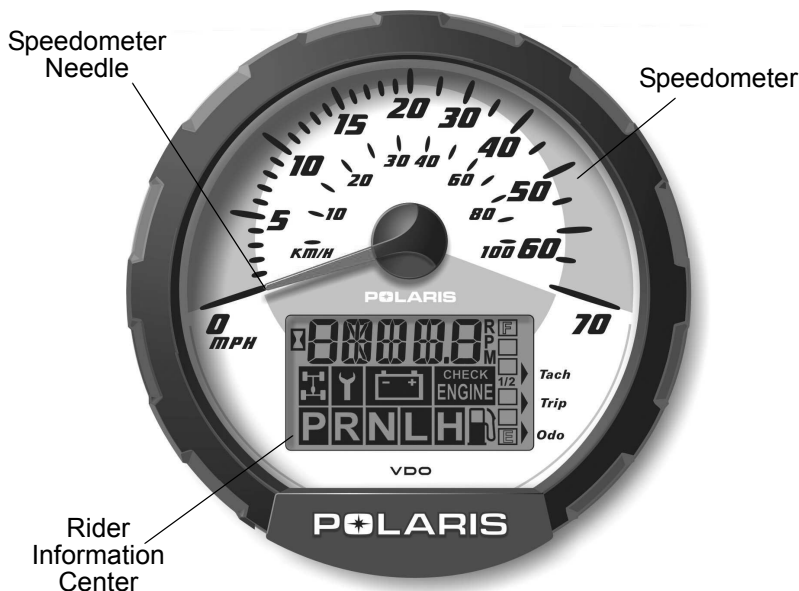

**NOTICE:** High water pressure may damage ATV components. Wash the ATV by hand or with a garden hose using mild soap.

Certain products, including insect repellents and chemicals, will damage the speedometer lens and other plastic surfaces. Do not use alcohol to clean the instrument cluster. Do not allow insect sprays to contact the lens. Immediately clean off any gasoline that splashes on the instrument cluster.

# FEATURES AND CONTROLS

## Instrument Cluster

### Rider Information Center

The rider information center is located in the instrument cluster. All segments will light up for 2.5 seconds at start-up. If the instrument cluster fails to illuminate, a battery over-voltage may have occurred and the instrument cluster may have shut off to protect the electronic speedometer. If this occurs, take the ATV to your Polaris dealer for proper diagnosis.

1. **Gear Indicator** - This indicator displays gear shifter position:

H = High Gear  
L = Low Gear  
N = Neutral  
R = Reverse Gear  
P = Park

2. **AWD Indicator** - This indicator illuminates when the AWD switch is in the AWD position.

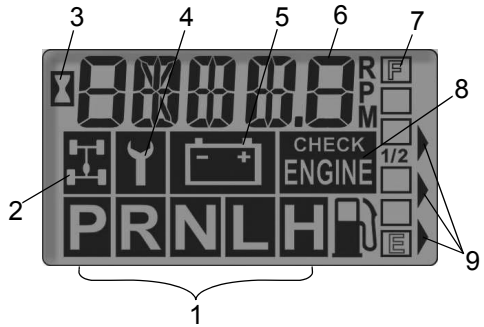

3. **Engine Hour Display Indicator**
4. **Service Interval/Diagnostic Mode Indicator**
5. **Low Battery and Over Voltage** - This warning usually indicates that the ATV is operating at an RPM too low to keep the battery charged. It may also occur when the engine is at idle and high electrical load (lights, cooling fan, accessories) is applied. Drive at a higher RPM or recharge the battery to clear the warning.
6. **Odometer/Tachometer/Tripmeter/ Hour Meter**
7. **Fuel Gauge** - The segments of the fuel gauge show the level of fuel in the fuel tank. When the last segment clears, a low fuel warning is activated. All segments will flash, FUEL will display in the LCD, and the speedometer needle will blink. Refuel immediately.
8. **Check Engine Warning Indicator** - The word HOT displays if the engine overheats. Do not operate the ATV if this warning appears. Serious engine damage could result.
9. **Mode Indicator**

# FEATURES AND CONTROLS

## Instrument Cluster

### Rider Information Center

#### Standard Modes

Use the MODE button to toggle through the mode options. The reverse override button is also the MODE button. See page 24. The transmission cannot be in reverse when using this feature.

#### Odometer Mode

The odometer records the miles traveled by the ATV.

#### Trip Meter Mode

The trip meter records the miles traveled by the ATV on each trip if it's reset before each trip. To reset the trip meter, select the trip meter mode. Press and hold the mode button (override button) until the total changes to 0. In the Rider Information Center, the trip meter display contains a decimal point, but the odometer displays without a decimal point.

#### Hour Meter Mode

This mode logs the total hours the engine has been in operation.

#### Tachometer Mode

The engine RPM is displayed digitally. Small fluctuations in the RPM from day to day may be normal because of changes in humidity, temperature and elevation.



# FEATURES AND CONTROLS

## Instrument Cluster

### Rider Information Center

#### Diagnostic Mode

The wrench icon will display when the gauge is in the diagnostic mode. To exit the diagnostic mode, turn the key switch off and on. Any movement of the tires will also cause the gauge to exit the diagnostic mode.

To enter the diagnostics mode:

1. Turn the key switch off and wait 10 seconds.
2. Lock the parking brake.
3. Place the transmission in neutral.
4. Hold the mode/reverse override button and turn the key switch on. Release the switch as soon as the display is activated.
5. Use the mode button to toggle through the diagnostic screens.

# FEATURES AND CONTROLS

## Instrument Cluster

### Rider Information Center

#### Diagnostic Mode

##### Battery Voltage Screen

View this screen to check battery voltage level.

##### Tachometer Screen

View the tachometer to check engine speed.

##### AWD Diagnostic Screen

The gauge indicates whether or not current is flowing through the AWD coil (only on models with switchable AWD). This screen is for informational purposes only. Please see your dealer for all major repairs.

##### Gear Circuit Diagnostic Screen

This screen displays the resistance value (in ohms) being read at the gear switch input of the gauge. This screen is for informational purposes only. Please see your dealer for all major repairs.

##### Programmable service interval

When the hours of engine operation equal the programmed service interval setting, the wrench icon will flash for 5 seconds each time the engine is started. When this feature is enabled, it provides a convenient reminder to perform routine maintenance. See page 39.

The service interval is programmed at 50 hours at the factory.

# FEATURES AND CONTROLS

## Instrument Cluster

### Rider Information Center

#### Diagnostic Mode

##### Programmable service interval

To enable or disable the service interval:

1. Enter the diagnostic mode.
2. Toggle to the service interval screen.
3. Press and hold the mode button for about 7 seconds, until either ON or OFF appears in the Rider Information Center, depending on your preference.

To reset the service interval:

1. Enter the diagnostic mode.
2. Toggle to the service interval screen.
3. Press and hold the mode button for 2-3 seconds, until the wrench icon flashes. Release the button.
4. Press and release the mode button once to advance the setting by one hour. Press and *hold* the mode button to advance the hours quickly.
5. If you scroll past the intended number, press and hold the button until the hours cycle back to zero.
6. When the desired setting is displayed, wait until the wrench icon stops flashing. The new service interval is now programmed.

# **FEATURES AND CONTROLS**

## **Instrument Cluster**

### **Rider Information Center**

#### **Diagnostic Mode**

##### **Miles/Kilometers toggle**

The display in the tripmeter and odometer can be changed to display either standard or metric units of measurement.

1. Enter the diagnostic mode.
2. Toggle to the screen that displays either kilometers (KM) or miles (MP).
3. Press and hold the mode button until the letters flash, then press and release the button once. When the display stops flashing, the mode has been set.

## **WARNING**

Failure to operate the ATV properly can result in a collision, loss of control, accident or overturn, which may result in serious injury or death. Read and understand all safety warnings outlined in the safety section of this owner's manual.

## **Break-In Period**

The break-in period for your new Polaris ATV is the first ten hours of operation, or the time it takes to use the first two full tanks of gasoline. No single action on your part is as important as following the procedures for a proper break-in. Careful treatment of a new engine and drive components will result in more efficient performance and longer life for these components.

**NOTICE:** Excessive heat build-up during the first three hours of operation will damage close-fitted engine parts and drive components. Do not operate at full throttle or high speeds during the first three hours of use.

# **OPERATION**

## **Break-In Period**

### **Engine and Drivetrain Break-in**

1. Fill the fuel tank with gasoline. See page 31. Always exercise extreme caution whenever handling gasoline.
2. Check the oil level on the dipstick. See page 69. Add oil if necessary to maintain the level between the safe and add marks.
3. Drive slowly at first. Select an open area that allows room to familiarize yourself with vehicle operation and handling.
4. Vary the throttle positions. Do not operate at sustained idle.
5. Perform regular checks on fluid levels, controls and areas outlined on the daily pre-ride inspection checklist. See page 45.
6. Pull only light loads.
7. During the break-in period, change both the oil and the filter at 20 hours or one month.

### **PVT Break-in (Clutches/Belt)**

A proper break-in of the clutches and drive belt will ensure a longer life and better performance. Break in the clutches and belt by operating at slower speeds during the break-in period as recommended. Pull only light loads. Avoid aggressive acceleration and high speed operation during the break-in period.

## Safe Operation Practices

1. Complete the recommended safety training before operating this vehicle. See page 7.
2. Do not allow anyone under 16 years of age to operate this vehicle. Do not allow anyone with cognitive or physical disabilities to operate this vehicle.
3. Never carry a passenger on this ATV.
4. Engine exhaust fumes are poisonous. Never start the engine or let it run in an enclosed area.
5. Before operating, learn how to use the auxiliary brake for emergency situations (if service brakes become inoperable).
6. Operate this vehicle off-road only. Never operate the vehicle on pavement or on any public street, road or highway, including dirt and gravel roads.
7. Use caution and drive at reduced speeds in conditions of reduced visibility such as fog, rain and darkness. Clean headlights frequently and replace burned out headlamps promptly.
8. Drive in a manner appropriate for your skills and operating conditions. Never operate at excessive speeds. Never attempt wheelies, jumps, or other stunts. Never remove your hands from the handlebars while operating, and always keep both feet on the footrests.
9. Never consume alcohol or drugs before or while operating an ATV.
10. Always use the size and type of tires specified for your vehicle. Always maintain proper tire pressure.
11. Never operate a damaged ATV. After any overturn or accident, have a qualified service dealer inspect the entire machine for possible damage.
12. Never operate the ATV on a frozen body of water.
13. Do not touch hot exhaust system components. Always keep combustible materials away from the exhaust system.
14. Always remove the ignition key when the vehicle is not in use to prevent unauthorized use.

## **OPERATION**

### **Know Your Riding Area/Tread Lightly**

Familiarize yourself with all laws and regulations concerning the operation of this off-road vehicle in your area. Respect the environment in which you ride. Find out where the designated riding areas are by contacting your Polaris dealer, a local riding club or local officials.

Help keep our trails open for recreational vehicle use. As an off-road enthusiast, you represent the sport and can set a good example (or a poor example) for others to follow. Tread lightly. Operate with respect for the terrain, avoid littering, and always stay on the designated trails.

### **Trail Etiquette**

Always practice good etiquette when riding. Allow a safe distance between your vehicle and other vehicles operating in the same area. Communicate to oncoming operators by signaling the number of vehicles in your group. When stopping, move your vehicle to the edge of the trail as far as possible to allow others to pass safely.



**Pre-Ride Checklist**

Failure to inspect and verify that the ATV is in safe operating condition before operating increases the risk of an accident. Always inspect the ATV before each use to make sure it's in safe operating condition.

<b>Item</b>	<b>Remarks</b>	<b>Page</b>
Brake system/lever travel	Ensure proper operation	27 78
Brake fluid	Ensure proper level	28
Auxiliary brake	Ensure proper operation	30
Front suspension	Inspect, lubricate if necessary	67
Rear suspension	Inspect, lubricate if necessary	67
Steering	Ensure free operation	-
Tires	Inspect condition and pressure	81
Wheels/fasteners	Inspect, ensure fastener tightness	81 82
Frame nuts, bolts, fasteners	Inspect, ensure tightness	-
Fuel and oil	Ensure proper levels	31 69
Coolant level (if applicable)	Ensure proper level	76 77
Coolant hoses (if applicable)	Inspect for leaks	-
Throttle	Ensure proper operation	26 105
Indicator lights/switches	Ensure operation	24
Engine stop switch	Ensure proper operation	25
Air filter, pre-filter	Inspect, clean	83
Air box sediment tube	Drain deposits whenever visible	-
Headlamp	Check operation, apply Polaris dielectric grease when lamp is replaced	25 86
Brake light/taillight	Check operation, apply Polaris dielectric grease when lamp is replaced	89
Riding gear	Wear approved helmet, goggles, and protective clothing	8

# OPERATION

## Starting the Engine

1. Position the vehicle on a level surface outdoors or in a well-ventilated area.
2. Place the transmission in PARK.
3. Lock the parking brake.

**Tip:** The starter interlock will prevent the engine from starting if the transmission is in gear and the brake is not engaged.

4. Turn the fuel valve on.
5. Sit on the vehicle.
6. Do not use the choke if starting a warm engine. Excessive use of the choke can cause the spark plug to become wet fouled.
7. If the engine is cold, pull the choke knob out until it stops.

**Tip:** The variable choke is fully on when the knob is pulled completely out. The choke is off when the knob is pushed completely in. The choke can be adjusted gradually, depending on how much choke is needed for starting. Be sure the choke is off during operation, as excess fuel washing into the engine oil will increase wear on engine components.

8. If the knob doesn't stay where positioned, increase the tension by rotating the tension adjusting nut clockwise.
9. Move the engine stop switch to RUN.
10. Do not press the throttle while starting the engine.

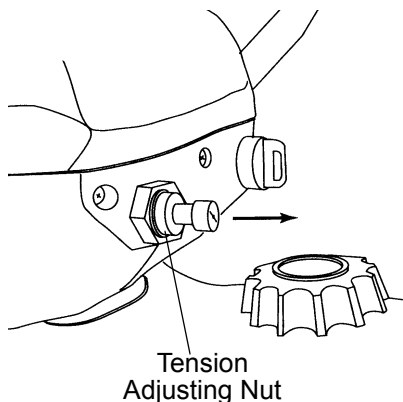

## Starting the Engine

11. Turn the ignition key past the ON position to engage the starter. Activate the starter for a maximum of five seconds, releasing the key when the engine starts.

**NOTICE:** Operating the vehicle immediately after starting could cause engine damage. Allow the engine to warm up for several minutes before operating the vehicle.

12. If the engine does not start, return the key to the OFF position and wait five seconds before attempting to start again. Activate the starter for another five seconds if necessary. Repeat this procedure until the engine starts.

**Tip:** If a warm engine has cooled to a point where it does not readily start, intermittent use of the choke button (pulled half way out) may be necessary. If the engine is over-choked when warm, depress the throttle lever fully while cranking to aid in starting. Release the throttle lever *immediately* after the engine starts. If the engine does not start and all conditions are favorable, change the spark plug and try again.

13. If the engine slows or stops, position the choke knob half way in to allow proper engine warm up. Vary the engine RPM slightly with the throttle to aid in warm-up. When the engine idles smoothly, push the choke completely in.

## Cold Weather Operation

If the ATV is used year-round, check the oil level frequently. A rising oil level could indicate the accumulation of contaminants such as water or excess fuel in the bottom of the crankcase. Water in the bottom of the crankcase can lead to engine damage and must be drained. Water accumulation increases as outside temperature decreases.

See your Polaris dealer for engine heater kits, which provide quicker warm-ups and easier starting in colder weather.

# OPERATION

## Driving Procedures



1. Wear a helmet and eye protection. See page 8.
2. Sit upright with both feet on the footrests and both hands on the handlebars.
3. Start the engine and allow it to warm up.
4. Shift the transmission into gear.
5. Check your surroundings and determine your path of travel.
6. Release the parking brake.
7. Slowly depress the throttle with your right thumb and begin driving.
8. Drive slowly. Practice maneuvering and using the throttle and brakes on level surfaces.

## Turning the Vehicle

Your ATV is equipped with a solid rear axle, which drives both rear wheels equally at all times. This means that the wheel on the outside of the turn must travel a greater distance than the inside wheel when turning and the inside tire must slip traction slightly.

To turn, steer in the direction of the turn, leaning your upper body to the inside of the turn while supporting your weight on the outer footrest. This technique alters the balance of traction between the rear wheels, allowing the turn to be made smoothly. The same leaning technique should be used for turning in reverse.

Practice making turns at slow speeds before attempting to turn at faster speeds.

**WARNING!** Turning improperly can result in vehicle overturn. Never turn abruptly or at sharp angles. Never turn at high speeds.



# OPERATION

## Driving on Slippery Surfaces

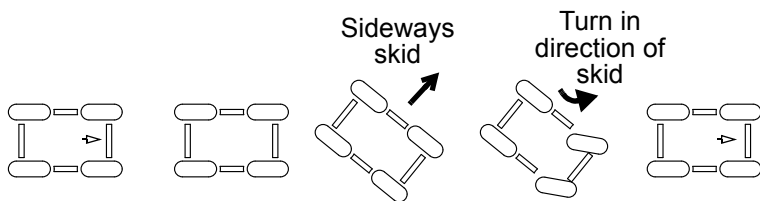

Whenever riding on slippery surfaces such as wet trails or loose gravel, or during freezing weather, follow these precautions:

1. Do not operate on excessively rough, slippery or loose terrain.
2. Slow down when entering slippery areas.
3. Engage AWD before wheels begin to lose traction.

**NOTICE:** Severe damage to drive train may occur if the AWD is engaged while the wheels are spinning. Allow the rear wheels to stop spinning before engaging AWD, or engage AWD before wheels begin to lose traction.

4. Maintain a high level of alertness, reading the trail and avoiding quick, sharp turns, which can cause skids.
5. Never apply the brakes during a skid. Correct a skid by turning the handlebars in the direction of the skid and shifting your body weight forward.

## Driving Uphill

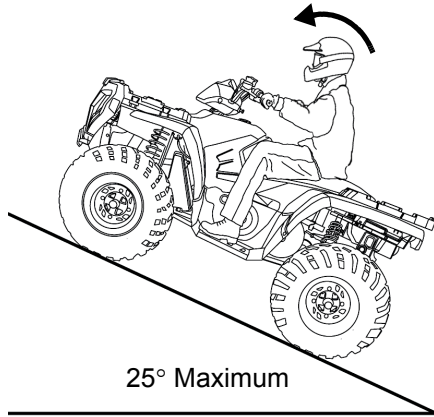

Braking and handling are greatly affected when operating in hilly terrain. Improper procedure could cause loss of control or overturn. When ever traveling uphill, follow these precautions:

1. Drive straight uphill.
2. Avoid steep hills (25° maximum).
3. Always check the terrain carefully before ascending any hill.
4. Never climb hills with excessively slippery or loose surfaces.
5. Keep both feet on the footrests.
6. Shift your weight uphill.
7. Proceed at a steady rate of speed and throttle opening. Opening the throttle suddenly could cause the ATV to flip over backwards.
8. Remain alert and be prepared to take emergency action. This may include quick dismounting of the vehicle.

## OPERATION

### Driving on a Sidehill (Sidehilling)

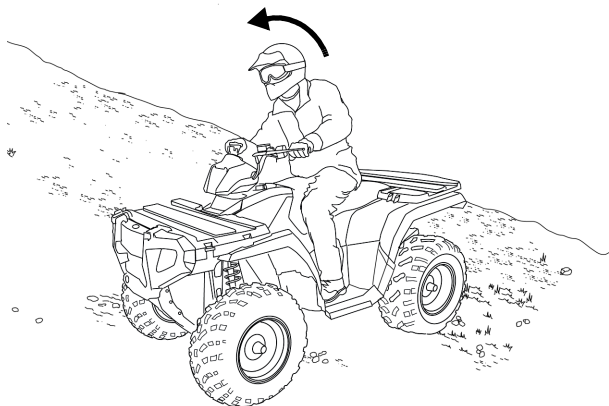

Driving on a sidehill is not recommended. Improper procedure could cause loss of control or overturn. Avoid crossing the side of any hill unless absolutely necessary.

If crossing a sidehill is *unavoidable*, follow these precautions:

1. Slow down.
2. Avoid crossing the side of a steep hill.
3. Shift body weight uphill.
4. Keep your feet on the footrests.
5. Steer slightly into the hill to maintain vehicle direction.
6. If the vehicle begins to tip, quickly turn the front wheel downhill, if possible, or dismount on the uphill side *immediately!*



## Driving Downhill



When driving downhill, follow these precautions:

1. Avoid steep hills (25° maximum).
2. Shift body weight uphill.
3. Drive straight downhill.
4. Slow down. Excessive speed when traveling downhill can cause loss of control.
5. Squeeze the brake lever gradually. Applying the brakes too firmly may cause the rear wheels to lock, which could result in loss of control.

## OPERATION

### Turning Around on a Hill (K-Turn)

If the vehicle stalls while climbing a hill, never back it down the hill!  
Use the K-turn to turn around.

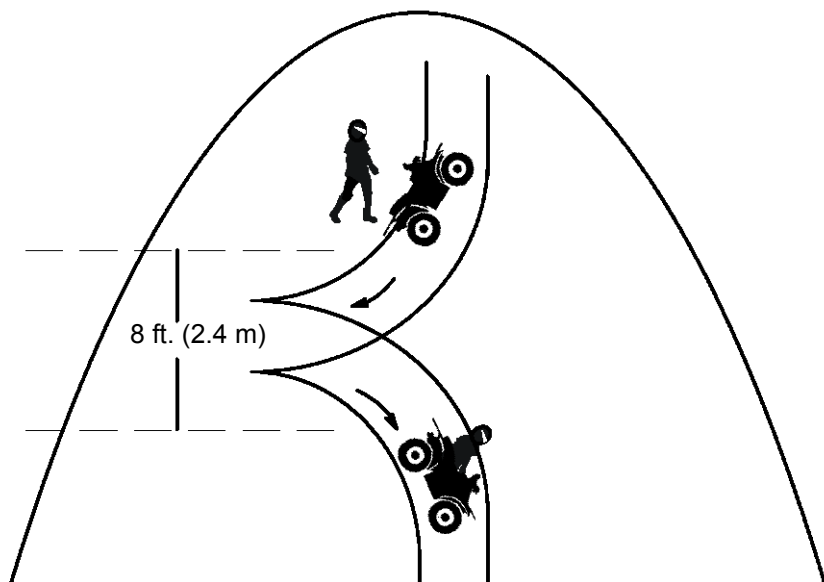

1. Stop and lock the parking brake while keeping body weight uphill.
2. Leave the transmission in forward and shut off the engine.
3. Dismount on the uphill side of the vehicle, or on the left if the vehicle is pointing straight uphill.
4. Staying uphill of the vehicle, turn the handlebars full left.
5. While holding the brake lever, release the parking brake lock and slowly allow the vehicle to roll around to your right until it's pointing across the hill or slightly downward.
6. Lock the parking brake. Remount the vehicle from the uphill side, keeping body weight uphill.
7. Start the engine with the transmission still in forward.
8. Release the parking brake and proceed *slowly*, controlling speed with the brake lever, until the vehicle is on more level ground.

## Driving Through Water

Your ATV can operate through water with a maximum recommended depth equal to the bottom of the footrests. Follow these procedures when operating through water:

1. Determine water depths and current before entering water.
2. Choose a crossing where both banks have gradual inclines.
3. Avoid operating through deep or fast-flowing water.

**NOTICE:** Major engine damage can result if the vehicle is not thoroughly inspected after operation in water. Perform the services outlined in the maintenance chart. See page 62. The following areas need special attention: engine oil, transmission oil, demand drive fluid, rear gearcase oil, and all grease fittings.

If the vehicle tips or overturns in water, or if the engine stops during or after operating in water, restarting can result in serious engine damage. Transport the vehicle to your dealer for service before restarting the engine. If this is not possible, follow the vehicle immersion inspection and drying procedures outlined on page 92, then see your dealer for service at the first opportunity.

4. After leaving water, test the brakes. Apply them lightly several times while driving slowly. The friction will help dry out the pads.

*If it's unavoidable to enter water deeper than the footrest level:*

- Proceed slowly. Avoid rocks and obstacles.
- Balance your weight carefully. Avoid sudden movements.
- Maintain a steady rate of speed. Do not make sudden turns or stops. Do not make sudden throttle changes.

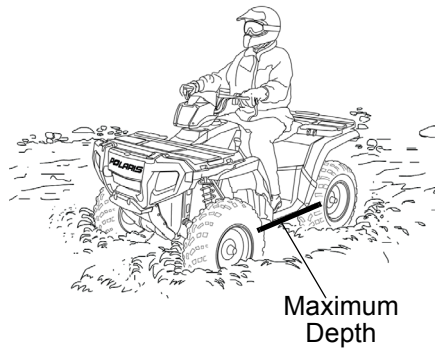

# OPERATION

## Driving Over Obstacles

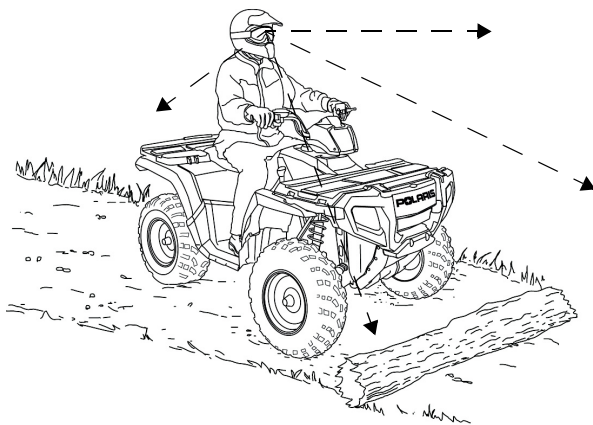

Follow these precautions when operating over obstacles:

1. Always check for obstacles before operating in a new area.
2. Look ahead and learn to read the terrain. Be constantly alert for hazards such as logs, rocks and low hanging branches.
3. Travel slowly and use extra caution when operating on unfamiliar terrain. Not all obstacles are immediately visible.
4. Never attempt to operate over large obstacles, such as rocks or fallen trees.

## Driving in Reverse

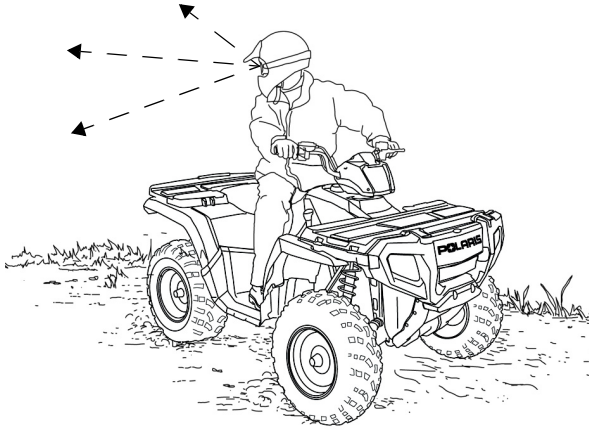

Follow these precautions when operating in reverse:

1. Always check for obstacles or people behind the vehicle.
2. Always avoid backing downhill.
3. Back slowly.
4. Apply the brakes *lightly* for stopping.
5. Avoid turning at sharp angles.
6. Never open the throttle suddenly.
7. Do not use the override button unless additional wheel speed is required for vehicle movement. Use the override with caution as rearward vehicle speed is greatly increased. Do not operate at wide open throttle. Operate the throttle just enough to maintain a desired speed.

**NOTICE:** Excessive throttle operation while in the speed limit mode may cause fuel to build in the exhaust, resulting in engine popping and/or engine damage.

# OPERATION

## Hauling Cargo

### **⚠ WARNING**

Overloading the vehicle or carrying or towing cargo improperly can alter vehicle handling and may cause loss of control or brake instability, which can result in serious injury or death. Always follow these precautions when hauling cargo:

**REDUCE SPEED AND ALLOW GREATER DISTANCES FOR BRAKING WHEN HAULING CARGO.**

**NEVER EXCEED THE MAXIMUM WEIGHT CAPACITY** of the vehicle. When determining the weight you are adding to the vehicle, include the weight of the operator, accessories, loads in the rack or box and the load on the trailer tongue. The combined weight of these items must not exceed the maximum weight capacity.

**CARGO WEIGHT DISTRIBUTION** should be 1/3 on the front rack and 2/3 on the rear rack. When operating over rough or hilly terrain, reduce speed and cargo to maintain stable driving conditions. Carrying loads on only one rack increases the possibility of vehicle overturn.

**CARRY LOADS AS LOW ON THE RACKS AS POSSIBLE.** Carrying loads high on the racks raises the center of gravity of the vehicle and creates a less stable operating condition.

**SECURE ALL LOADS BEFORE OPERATING.** Unsecured loads can create unstable operating conditions, which could result in loss of control of the vehicle.

**OPERATE ONLY WITH STABLE AND SAFELY ARRANGED LOADS.** When handling off-centered loads that cannot be centered, securely fasten the load and operate with extra caution. Always attach the tow load to the hitch point designated for your vehicle.

**HEAVY LOADS CAN CAUSE BRAKING AND CONTROL PROBLEMS.** Use extreme caution when applying brakes with a loaded vehicle. Avoid terrain or situations that may require backing downhill.

**USE EXTREME CAUTION** when operating with loads that extend over the rack sides. Stability and maneuverability may be adversely affected, causing the vehicle to overturn.

**DO NOT BLOCK THE FRONT HEADLIGHT BEAM** when carrying loads on the front rack.

**DO NOT TRAVEL FASTER THAN THE RECOMMENDED SPEEDS.** Vehicle should never exceed 10 mph (16 kph) while towing a load on a level surface. Vehicle speed should never exceed 5 mph (8 kph) when towing loads in rough terrain, while cornering, or while ascending or descending a hill.

## Hauling Cargo

Never exceed the weight capacities specified for your ATV on warning labels and in the specifications section of this manual.

Cargo weight should be evenly distributed (1/3 on the front rack and 2/3 on the rear rack) and mounted as low as possible.

When operating over rough or hilly terrain, reduce speed and cargo weight to maintain stable driving conditions. Do not obstruct the headlight beam with cargo. Use low forward gear when hauling or towing heavy cargo to extend belt life.

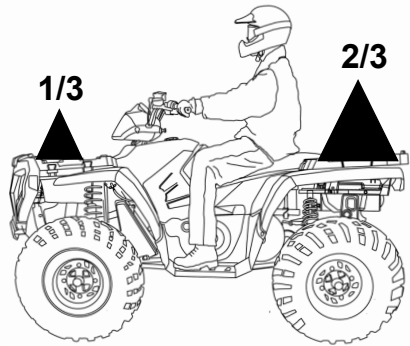

## Towing Loads

Always attach a towed load to the hitch point. Remove the hitch from the ATV when not towing a trailer. If towing a load, reduce rear rack cargo weight by the amount of tongue weight.

- The combination of rear rack cargo weight and tongue weight must not exceed the rear rack capacity.
- The total load (operator, accessories, cargo and weight on hitch) must not exceed the maximum weight capacity of the vehicle.

**NOTICE:** Using an improper hitch or exceeding the maximum tongue weight capacity can result in serious damage to the vehicle and will void your ATV warranty. Never install a hitch longer than 4" (10 cm). Never install automotive accessories on your Polaris ATV. Always install Polaris-approved (or equivalent) accessories designed for ATV use.

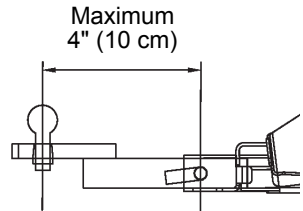

# OPERATION

## Parking on an Incline

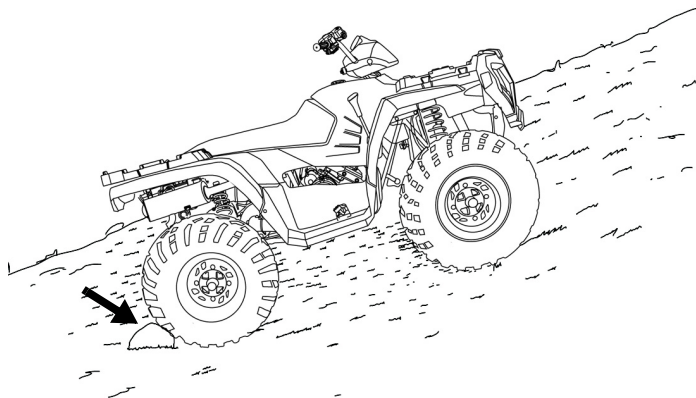

Avoid parking on an incline if possible. If it's unavoidable, follow these precautions:

1. Stop the engine.
2. Place the transmission in PARK.
3. Lock the parking brake.
4. Always block the rear wheels on the downhill side.
5. Turn the fuel valve off.



# **EMISSION CONTROL SYSTEMS**

## **Noise Emission Control System**

Do not modify the engine, intake or exhaust components, as doing so may affect compliance with U.S.A. EPA noise control requirements (40 CFR 205) and local noise level requirements.

## **Operation on Public Lands in the U.S.A.**

Your Polaris vehicle has a spark arrester that was tested and qualified to be in accordance with the USFS standard 5100-1c. Federal law requires that this spark arrester be installed and functional when the vehicle is operated on public lands.

Operation of off-road vehicles on public lands in the U.S.A. is regulated by 43 CFR 420. Violations are subject to monetary penalties. Federal regulations can be viewed online at [www.gpoaccess.gov/ecfr/](http://www.gpoaccess.gov/ecfr/).

## **Crankcase Emission Control System**

This engine is equipped with a closed crankcase system. Blow-by gases are forced back to the combustion chamber by the intake system. All exhaust gases exit through the exhaust system.

## **Exhaust Emission Control System**

The emissions from the exhaust of this vehicle are controlled by engine design, including factory-set fuel delivery and ignition. The engine and related components must be maintained at Polaris specifications to achieve optimal performance.

Engine idle speed is the only adjustment Polaris recommends that the operator perform. Any other adjustments should be performed by an authorized Polaris dealer.

The vehicle compliance labels can be found on the frame tubing of the vehicle.

## **Electromagnetic Interference**

This spark ignition system complies with Canadian ICES-002.

This vehicle complies with the EMC requirements of European directives 97/24/EC and 2004/108/EC.

# MAINTENANCE

## Periodic Maintenance Chart

Careful periodic maintenance will help keep your vehicle in the safest, most reliable condition. Inspection, adjustment and lubrication of important components are explained in the periodic maintenance chart.

Inspect, clean, lubricate, adjust and replace parts as necessary. When inspection reveals the need for replacement parts, use genuine Polaris parts available from your Polaris dealer.

Record maintenance and service in the Maintenance Log beginning on page 129.

Service and adjustments are important for proper vehicle operation. If you're not familiar with safe service and adjustment procedures, have a qualified dealer perform these operations.

Maintenance intervals in the following chart are based upon average riding conditions and an average vehicle speed of approximately 10 miles per hour. Vehicles subjected to severe use must be inspected and serviced more frequently.

### Severe Use Definition

- Frequent immersion in mud, water or sand
- Racing or race-style high RPM use
- Prolonged low speed, heavy load operation
- Extended idle
- Short trip cold weather operation

Pay special attention to the oil level. A rise in oil level during cold weather can indicate contaminants collecting in the oil sump or crankcase. Change oil immediately if the oil level begins to rise. Monitor the oil level, and if it continues to rise, discontinue use and determine the cause or see your dealer.

## Periodic Maintenance Chart

### **⚠ WARNING**

Improperly performing the procedures marked with a ■ could result in component failure and cause an accident, which may result in serious injury or death. Always have an authorized Polaris dealer perform these services.

### **Maintenance Chart Key**

- ▶ Perform these operations more often for vehicles subjected to severe use.
- E** Emission-related service (Failure to conduct this maintenance will not void the emissions warranty but may affect emissions.)
- Have an authorized Polaris dealer perform these services.

# MAINTENANCE

## Periodic Maintenance Chart

Perform all services at whichever maintenance interval is reached first.

Item	Maintenance Interval (whichever comes first)			Remarks
	Hours	Calendar	Miles (Km)	
■ Steering	-	Pre-Ride	-	Make adjustments as needed. See Pre-Ride Checklist on page 45.
▶ Front suspension	-	Pre-Ride	-	
▶ Rear suspension	-	Pre-Ride	-	
Tires	-	Pre-Ride	-	
▶ Brake fluid level	-	Pre-Ride	-	
▶ Brake lever travel	-	Pre-Ride	-	
Brake system	-	Pre-Ride	-	
Wheels/fasteners	-	Pre-Ride	-	
Frame fasteners	-	Pre-Ride	-	
▶ Engine oil level	-	Pre-Ride	-	
▶ E Air filter, pre-filter	-	Daily	-	Inspect; clean often; replace as needed
▶ Air box sediment tube	-	Daily	-	Drain deposits when visible
Coolant	-	Daily	-	Check level daily, change coolant every 2 years
Headlight/taillight/worklight	-	Daily	-	Check operation; apply dielectric grease if replacing lamps
▶ E Air filter, main element	-	Weekly	-	Inspect; replace as needed
Recoil housing	-	Weekly	-	Drain water as needed, check often if operating in wet conditions
▶ ■ Brake pad wear	10 H	Monthly	100 (160)	Inspect periodically
Battery	20 H	Monthly	200 (320)	Check terminals; clean; test
▶ Demand drive fluid	25 H	Monthly	250 (400)	Inspect level; change yearly
▶ Rear gearcase oil (if equipped)	25 H	Monthly	250 (400)	Inspect level; change yearly
▶ Transmission oil	25 H	Monthly	250 (400)	Inspect level; change yearly
▶ Engine breather filter (if equipped)	25 H	Monthly	250 (400)	Inspect; clean if needed

▶ Perform these procedures more often for vehicles subjected to severe use.

E Emission-Related Service

■ Have an authorized Polaris dealer perform these services.

# MAINTENANCE

## Periodic Maintenance Chart

Item		Maintenance Interval (whichever comes first)			Remarks
		Hours	Calendar	Miles (Km)	
▶	General lubrication	50 H	3 M	500 (800)	Lubricate all fittings, pivots, cables, etc.
	Carburetor float bowl	50 H	6 M	500 (800)	Drain bowl periodically and prior to storage
■ E	Throttle Cable/ ETC Switch	50 H	6 M	500 (800)	Inspect; adjust; lubricate; replace if necessary
■ E	Choke cable	50 H	6 M	500 (800)	Inspect; adjust; lubricate; replace if necessary
E	Carburetor air intake ducts/flange	50 H	6 M	500 (800)	Inspect duct for proper sealing/air leaks
	Drive belt	50 H	6 M	500 (800)	Inspect; adjust; replace as needed
	Cooling system	50 H	6 M	1000 (1600)	Inspect coolant strength seasonally; pressure test system yearly
▶	Engine oil change	100 H	6 M	1000 (1600)	Perform a break-in oil change at one month
▶	Oil filter change	100 H	6 M	1000 (1600)	Replace with oil change
■ E	Valve clearance	100 H	12 M	1000 (1600)	Inspect; adjust
■ E	Fuel system/filter	100 H	12 M	1000 (1600)	Check for leaks at tank cap, lines, fuel valve, filter, pump, carburetor; replace lines every two years
▶	Radiator (if applicable)	100 H	12 M	1000 (1600)	Inspect; clean external surfaces
▶	Cooling hoses (if applicable)	100 H	12 M	1000 (1600)	Inspect for leaks
▶	Engine mounts	100 H	12 M	1000 (1600)	Inspect
	Exhaust muffler/pipe	100 H	12 M	1000 (1600)	Inspect
■ E	Spark plug	100 H	12 M	1000 (1600)	Inspect; replace as needed
■ E	Ignition timing	100 H	12 M	1000 (1600)	Inspect
▶	Wiring	100 H	12 M	1000 (1600)	Inspect for wear, routing, security; apply dielectric grease to connectors subjected to water, mud, etc.

# MAINTENANCE

## Periodic Maintenance Chart

Item		Maintenance Interval (whichever comes first)			Remarks
		Hours	Calendar	Miles (Km)	
■	Clutches (drive and driven)	100 H	12 M	1000 (1600)	Inspect; clean; replace worn parts
■	Front wheel bearings	100 H	12 M	1000 (1600)	Inspect; replace as needed
■	Brake fluid	200 H	24 M	2000 (3200)	Change every two years
	Spark arrestor	300 H	36 M	3000 (4800)	Clean out
	Idle speed	-			Adjust as needed
■	Toe adjustment	-			Inspect periodically; adjust when parts are replaced
	Headlight aim	-			Adjust as needed

► Perform these procedures more often for vehicles subjected to severe use.

E Emission-Related Service

■ Have an authorized Polaris dealer perform these services.

## Lubrication Guide

Check and lubricate all components at the intervals outlined in the Periodic Maintenance Chart beginning on page 62. Items not listed in the chart should be lubricated at the General Lubrication interval.

The a-arms and lower control arms are lubricated at the factory, and no additional lubrication will be needed. However, if these components are subjected to severe use, grease zerks have been provided for additional lubrication at the user's discretion.

Item	Lube	Capacity at Fluid Change	Inspection Procedure
Engine Oil	Polaris Premium 4 Synthetic 0W40	2 qt. (1.9 l)	Maintain level in safe range on dipstick. See page 69.
Brake Fluid	DOT 4 Only	---	Maintain level between fill lines. See page 28.
Transmission Oil	Polaris AGL Synthetic Gearcase Lube	32 oz. (948 ml)	Maintain level at bottom of fill hole threads. See page 73.
Demand Drive Fluid (Front Gearcase)	Demand Drive Plus Fluid	9 oz. (265 ml)	Maintain level at bottom of fill hole threads. See page 74.
Front Prop Shaft Yoke	Polaris Premium U-Joint Lube	---	Grease fittings (3 pumps maximum) every 500 miles, before long periods of storage, or after pressure washing or submerging.

Front Prop Shaft Yoke

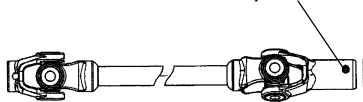

# MAINTENANCE

## Engine Oil

### Oil Recommendations

Polaris Premium 4 All Season synthetic engine oil has been specially formulated for use in Polaris 4-cycle engines. It's a fully synthetic, high performance, multi-viscosity oil designed to provide the ultimate in lubrication performance and protection. See page 117 for the part numbers of Polaris products.

Premium 4 possesses unsurpassed film strength over the widest possible temperature range. It resists viscosity and frictional breakdown in ambient temperatures from  $-40^{\circ}$  F. to  $120^{\circ}$  F. ( $-40^{\circ}$  to  $+49^{\circ}$  C.). Its exceptional frictional properties result in more efficient operation, more power output and lower fuel consumption.

Although Polaris Premium 4 is the only oil recommended for use in this engine, use of any API certified SH oil is allowable as long as it's 0W-40. Oil may need to be changed more frequently if Polaris Premium 4 is not used. Follow the manufacturer's recommendations for ambient temperature operation.

**NOTICE:** Mixing brands or using a non-recommended oil may cause serious engine damage. Always use the recommended oil. Never substitute or mix oil brands.



## Engine Oil Oil Level

Access the oil dipstick and fill tube from the left side of the ATV.

A rising oil level between checks in cool weather driving can indicate contaminants such as gas or moisture collecting in the crankcase. If the oil level is over the full/safe mark, change the oil immediately.

1. Position the vehicle on a level surface.
2. Start the engine. Allow it to idle for 20-30 seconds. Stop the engine.
3. Remove the dipstick. Wipe it dry with a clean cloth.
4. Reinstall the dipstick completely.
5. Remove the dipstick and check the oil level. Maintain the oil level in the safe range. Do not overfill.

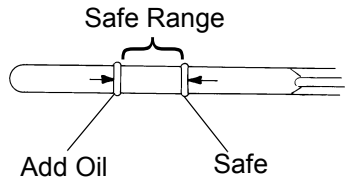
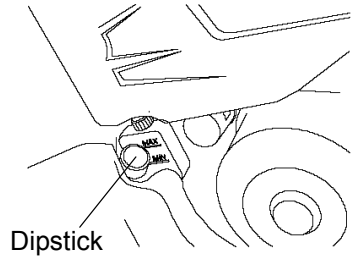

# MAINTENANCE

## Oil and Filter Change

Always change the oil and filter at the intervals outlined in the Periodic Maintenance Chart beginning on page 62. Always change the oil filter whenever changing oil.

1. Position the vehicle on a level surface.
2. Start the engine. Allow it to idle for two to three minutes.
3. Stop the engine.
4. Clean the area around the drain plug.
5. Place a drain pan under the oil tank.
6. Remove the drain plug. Allow the oil to drain completely.

**CAUTION!** Hot oil can cause burns to skin. Do not allow hot oil to contact skin.

7. Install a new sealing washer on the drain plug. The sealing surfaces on drain plug and crankcase should be clean and free of burrs, nicks or scratches.
8. Reinstall the drain plug. Torque to 14-17 ft. lbs. (19-23 Nm).
9. Disconnect the lower oil delivery hose and remove the screen fitting from the oil tank. Clean the fitting. *The fitting threads must be sealed with LOCTITE PST 505 or PTFE seal tape.*
10. Reinstall the screen fitting and rotate the fitting clockwise a minimum of 2 1/2 turns into the tank threads. Continue to rotate the fitting until the nipple of the fitting aligns with the mark on the tank. Do not over-tighten. Maximum torque for the screen fitting is 25 ft. lbs. (34 Nm).
11. Reattach the oil line.

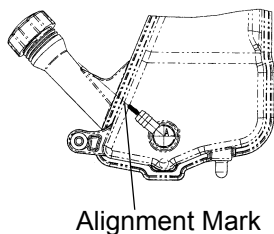
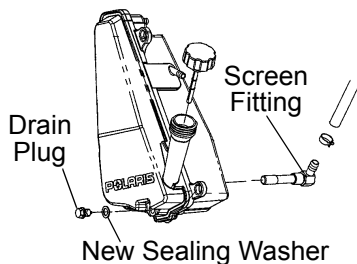

## Oil and Filter Change

12. Place shop towels beneath the oil filter. Using an oil filter wrench, turn the filter counter-clockwise to remove it.
  13. Using a clean dry cloth, clean the filter sealing surface on the crankcase.
  14. Lubricate the o-ring on the new filter with a film of fresh engine oil. Check to make sure the o-ring is in good condition.
  15. Install the new filter and rotate it clockwise by hand until the filter gasket contacts the sealing surface, then turn it an additional 1/2 turn.
  16. Approximately one cup of engine oil will remain in the crankcase. To drain, remove the drain plug on the lower right side of the crankcase. The sealing surfaces on the drain plug and crankcase should be clean and free of burrs, nicks or scratches.
  17. Reinstall the drain plug. Torque to 14 ft. lbs. (19 Nm).
  18. Remove the dipstick.
  19. Add two quarts (1.9 l) of recommended oil. Reinstall the dipstick.
- Tip:** If the sump is not drained, add about 1 3/4 quarts (1.6 l) initially.
20. Place the transmission in PARK.
  21. Lock the parking brake.
  22. **Prime the oil pump using the procedure on page 72.** Then stop the engine and inspect for leaks.
  23. Check the oil level. Add oil as needed to bring the level to the upper mark on the dipstick.
  24. Dispose of used filter and oil properly.

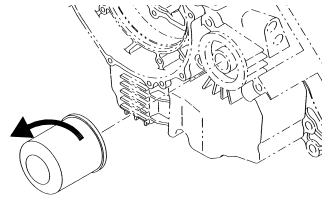

# MAINTENANCE

## Oil and Filter Change

### Oil Pump Priming

This priming procedure must be performed whenever the oil hose connection between the oil tank and pump inlet has been disconnected.

1. Clamp or pinch off the vent line approximately 2" (5 cm) from the oil tank, between the end of the oil tank vent fitting and the vent line's pressure relief slit.
2. Start the engine. Allow it to idle for 10-20 seconds.
3. Remove the vent line clamp. If the line is bled properly, you should hear a rush of air, indicating that the line is properly primed and ready for operation.

**Tip:** If you do not hear air, the line has not bled. Repeat the priming procedure.

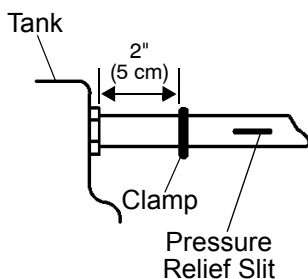

## Transmission Oil

Always check and change the transmission oil at the intervals outlined in the Periodic Maintenance Chart beginning on page 62. Maintain the oil level at the bottom of the fill plug hole threads. We recommend the use of Polaris Premium AGL Synthetic Gearcase Lubricant. See page 117 for the part numbers of Polaris products.

The fill plug is located on the left side of the ATV, under the rear fender, behind the wheel.

The drain plug is located on the right side of the gearcase, on the right side of the ATV, behind the wheel well.

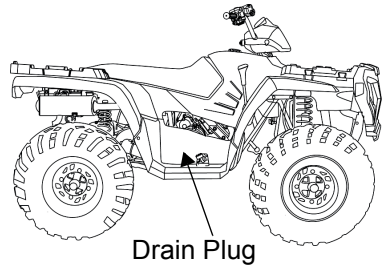
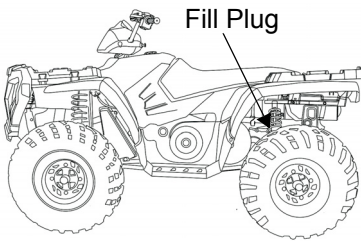

## Oil Check

1. Position the vehicle on a level surface.
2. Remove the fill plug.
3. Check the oil level.
4. Reinstall the fill plug. Torque to 22 ft. lbs. (30 Nm).
5. Reinstall the footwell.

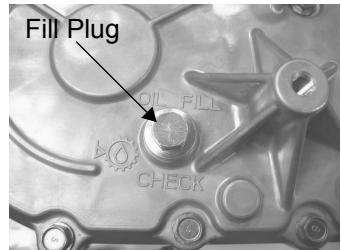

# MAINTENANCE

## Transmission Oil

### Oil Change

1. Remove the fill plug.
2. Place a drain pan under the gearcase.
3. Remove the drain plug. Allow the oil to drain completely.
4. Clean and reinstall the drain plug. Torque to 22 ft. lbs. (30 Nm).
5. Add 32 oz. (948 ml) of the recommended oil.
6. Reinstall the fill plug. Torque to 22 ft. lbs. (30 Nm).
7. Check for leaks. Dispose of used oil properly.

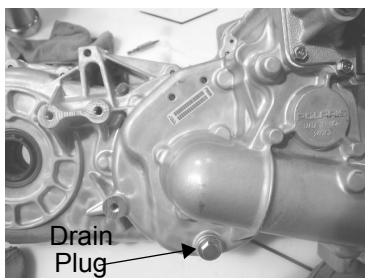

### Front Gearcase (Demand Drive) Fluid

Always check and change the demand drive fluid at the intervals outlined in the Periodic Maintenance Chart beginning on page 62. We recommend the use of Demand Drive Plus Fluid. Use of other fluids may result in improper operation of components. See page 117 for the part numbers of Polaris products.

Maintain the fluid level at the bottom of the fill hole threads. See below for capacity.

The fill plug is located on the right side of the demand drive unit. The drain plug is located on the bottom right side of the unit.

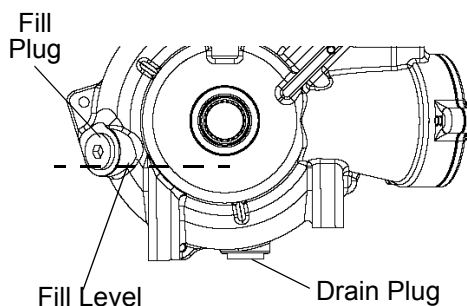

Demand Drive Capacity	
Sportsman 500	9 oz. (265 ml)

# MAINTENANCE

## Front Gearcase (Demand Drive) Fluid

### Fluid Check

1. Position the vehicle on a level surface. Remove the fill plug. Check the fluid level.
2. Add the recommended demand drive fluid as needed to bring the level to the bottom of the fill hole threads.
3. Reinstall the fill plug. Torque to 8-10 ft. lbs. (11-14 Nm).

### Fluid Change

1. Position the vehicle on a level surface. Remove the fill plug. Place a drain pan under the demand drive unit.
2. Remove the drain plug. Allow the fluid to drain completely.
3. Clean and reinstall the drain plug. Torque to 11 ft. lbs. (15 Nm).
4. Add the recommended fluid. See page 74 for capacity. Maintain the fluid level at the bottom of the fill hole threads.
5. Reinstall the fill plug. Torque to 8-10 ft. lbs. (11-14 Nm).
6. Check for leaks. Dispose of used fluid properly.

# MAINTENANCE

## Cooling System

The engine coolant level is controlled, or maintained, by the recovery system. The recovery system components are the recovery bottle, the radiator filler neck, the radiator pressure cap and the connecting hose.

As coolant operating temperature increases, the expanding (heated) excess coolant is forced out of the engine, past the pressure cap, and into the recovery bottle. As engine coolant temperature decreases the contracting (cooled) coolant is drawn back up from the bottle, past the pressure cap, and into the radiator.

Some coolant level drop on new vehicles is normal as the system is purging itself of trapped air. Check the coolant level and maintain as recommended by adding coolant to the recovery bottle.

Polaris recommends the use of Polaris Premium 60/40 anti-freeze/coolant or a 50/50 mixture of high quality aluminum compatible anti-freeze/coolant and distilled water. Polaris Premium 60/40 is already premixed and ready to use. Do not dilute with water. See page 117 for the part numbers of Polaris products.

Always follow the manufacturer's mixing recommendations for the freeze protection required in your area.

## Recovery Bottle Coolant

The recovery bottle is located on the left side of the vehicle.

1. Remove the left side panel. See page 80.
2. Maintain the coolant level between the minimum and maximum marks on the bottle (when the fluid is cool).
3. Add coolant as needed.

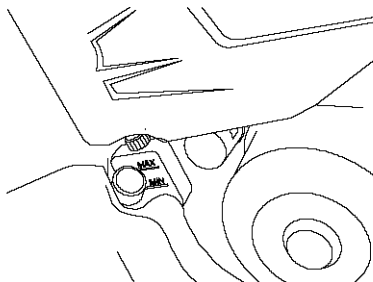



## Cooling System Radiator Coolant

To ensure that the coolant maintains its ability to protect the engine, Polaris recommends that you drain the system completely every two years and add a fresh mixture of antifreeze and water.

Replace the coolant any time the cooling system has been drained for maintenance or repair. If the recovery bottle has run dry, check the level in the radiator. Add coolant as needed.

**CAUTION!** Escaping steam can cause burns. Never remove the pressure cap while the engine is warm or hot. Always allow the engine to cool before removing the pressure cap.

1. Open the front box cover and pull open the access door.
2. Remove the pressure cap.
3. Using a funnel, slowly add coolant through the radiator filler neck.
4. Reinstall the pressure cap. Use of a non-standard pressure cap will not allow the recovery system to function properly. Contact your dealer for the correct replacement part.
5. Secure the access door.
6. Secure the box cover.

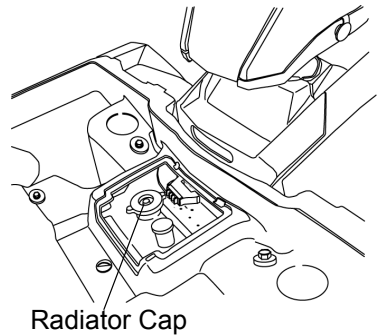

# MAINTENANCE

## Brakes

### Hand Brake

The front and rear brakes are hydraulic disc brakes, activated by moving the single brake lever toward the handlebar. These brakes are self-adjusting.

Under normal operation, the diaphragm extends into the reservoir as fluid level drops. If the fluid level is low and the diaphragm is not extended, a leak is likely and the diaphragm should be replaced. To ensure proper diaphragm operation, always fill the reservoir as needed whenever the cover is loosened or removed. Do not overfill.

**WARNING!** An over-full master cylinder may cause brake drag or brake lock-up, which could result in serious injury or death. Maintain brake fluid at the recommended level. Do not overfill.

The following checks are recommended to keep the brake system in good operating condition. Check more often if brakes are used heavily under normal operation.

1. Always keep brake fluid at an adequate level. See page 28.
2. Check the brake system for fluid leaks.
3. Check the brakes for excessive travel or spongy feel.
4. Check the friction pads for wear, damage and looseness. Replace brake pads when they are worn to  $3/64$ " (1 mm).
5. Check the security and surface condition of the disc.

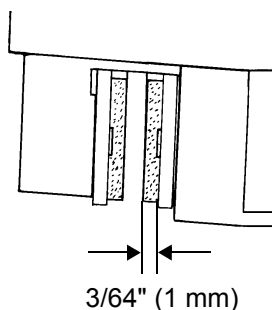

### Auxiliary Foot Brake

The hydraulic auxiliary brake system requires no adjustment. Check the brake fluid level frequently for the auxiliary brake system. See page 30.

## Toe Alignment

Use the following procedure to check the toe alignment of the vehicle. The recommended toe alignment is 1/8" to 1/4" (3-6 mm) toe out.

**WARNING!** Severe injury or death can result from improper toe alignment and adjustment. Do not attempt to adjust tie rod alignment. All tie rod adjustments should be performed by an authorized Polaris dealer.

1. Position the vehicle on a level surface.
2. Place the handlebars in a straight-ahead position.
3. Tie a length of string between two stands as shown in the illustration. Position the stands so that the string is flush with the side of the rear tire. If available, you may use a long straight-edge instead of string.
4. Measure the distance from the string to the rim at the front (1) and rear (2) of the front rim.

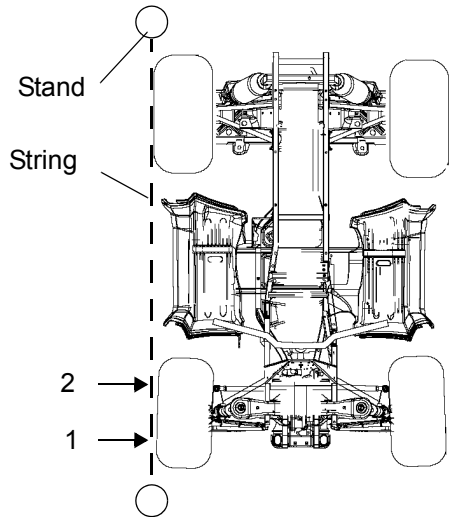

The rear measurement should be 1/16"-1/8" (2-3 mm) more than the front measurement on each side of the vehicle to obtain the recommended 1/8" to 1/4" (3-6 mm) toe out alignment.

5. Repeat the measurement procedure on the other side of the vehicle.
6. If you discover improper alignment, see your Polaris dealer for service.

# MAINTENANCE

## Steering Assembly

The steering assembly of the ATV should be checked periodically for loose nuts and bolts. If loose nuts and bolts are found, see your Polaris dealer for service before operating the vehicle.

## Side Panel Removal

1. Remove the seat.
2. Grasp the rear of the side panel near the rear cab. With a firm motion, pull the panel outward to disengage the side panel from the grommet.
3. Pull the panel downward and rearward to remove it.

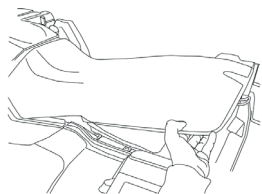

Step 1

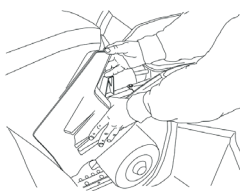

Step 2

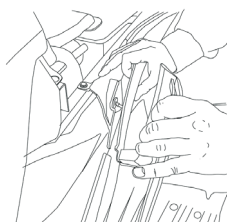

Step 3

## Footwell Removal

1. Remove the four screws on the bottom of the footwell.
2. Use a flat screwdriver or sidecutters to remove the plastic rivets securing the footwell to the fenders.
3. Remove the footwell.

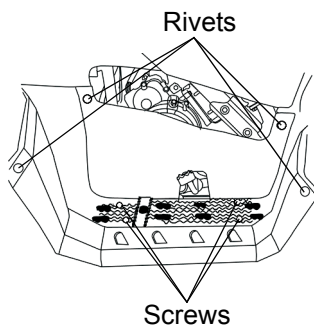

## Tires

### **⚠ WARNING**

Operating your ATV with worn tires, improperly inflated tires, non-standard tires or improperly installed tires will affect vehicle handling and could cause an accident resulting in serious injury or death. Always follow all tire maintenance procedures as outlined in this manual and on the labels on the vehicle. Always use original equipment size and type when replacing tires.

Refer to the specifications section beginning on page 118 for recommended tire type, size and pressure.

### **Tire Tread Depth**

Always replace tires when tread depth is worn to 1/8" (3 mm) or less.

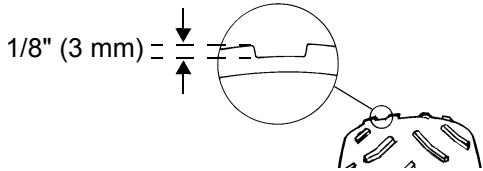

### **Front Wheel Hub Tightening**

Front wheel bearing tightness and spindle nut retention are critical component operations. All service must be performed by your authorized Polaris dealer.

### **Wheel Removal**

1. Stop the engine.
2. Place the transmission in PARK.
3. Lock the parking brake.
4. Loosen the wheel nuts slightly.

**WARNING!** Do not service axle nuts that have a cotter pin installed. See your Polaris dealer.

5. Elevate the side of the vehicle by placing a suitable stand under the footrest frame.
6. Remove the wheel nuts.
7. Remove the wheel.

# MAINTENANCE

## Tires

### Wheel Installation

1. Place the transmission in PARK.
2. Lock the parking brake.
3. Place the wheel on the hub with the valve stem toward the outside and rotation arrows on the tire pointing toward forward rotation.
4. Install the wheel nuts and finger-tighten them.
5. Lower the vehicle to the ground.
6. Torque the wheel nuts to specification.

**WARNING!** Loose nuts could cause a tire to come off during operation, which could result in an accident or overturn. Always ensure that all nuts are torqued to specification.



Cast Aluminum



90 ft. lbs.  
(122 Nm)



Steel



27 ft. lbs.  
(37 Nm)

### Wheel Nut Torque Specifications

Check the wheel nut torques occasionally and when they've been loosened for maintenance service.

Nut Type	Nut Torque
Lug Nut	90 ft. lbs. (122 Nm)
2-Piece Flange Nut	27 ft. lbs. (37 Nm)

# MAINTENANCE

## Air Filter

1. Remove the seat.
2. Release the air box cover clips, and remove the air box cover.
3. Loosen the clamp and remove the filter.
4. Remove the fabric type pre-filter from the main filter. Wash the pre-filter in soapy water, then rinse and let dry.
5. Reinstall the pre-filter over the main filter. Install a new main filter if needed.
6. Reinstall the filter into the air box and tighten the clamp. Do not over-tighten the clamp, as filter damage could occur.
7. Reinstall the air box cover and the seat.

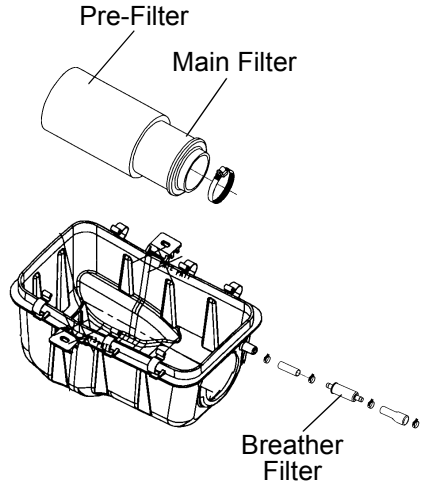

# MAINTENANCE

## Breather Filter/Hose

The breather filter is on the hose that runs between the engine and air box. See illustration above.

1. Remove the left side panel. See page 80.
2. Remove the hose clamps from the filter and pull the filter out of the hoses.
3. Inspect the filter for debris. Blow gently through the filter in the direction of the arrow to check for clogging. Replace a damaged or clogged filter.
4. Check the hoses for cracks, deterioration, abrasion, or leaks. Replace as needed.
5. Reinstall the filter and hose clamps. The filter is effective with the arrow pointing in either direction.

**NOTICE:** Operation of your vehicle without a breather filter can cause engine damage. Always reinstall the breather filter after removing it for service.



## Fuse Replacement

If the engine stops or will not start, or if you experience other electrical failures, a fuse may need replacement.

Locate and correct any short circuits that may have caused the blown fuse, then replace the fuse. Spare fuses are provided in a compartment on the top of the access door.

1. Open the front box cover.
2. Open the access door.
3. Remove the suspect fuse from the fuse panel. If the fuse is blown, install a new fuse with the same amperage.
4. Secure the access door.
5. Secure the box cover.

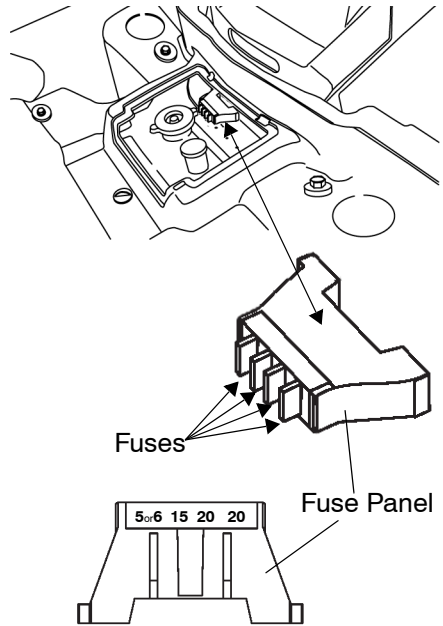

# MAINTENANCE

## Lights

Poor lighting can result in reduced visibility when driving. Headlight and taillight lenses become dirty during normal operation. Clean lights frequently and replace burned out lamps promptly. Always make sure lights are adjusted properly for best visibility.

### Headlight Lamp Replacement

When servicing a halogen lamp, don't touch the lamp with bare fingers. Oil from your skin leaves a residue, causing a hot spot that will shorten the life of the lamp.

1. Remove the two screws on the lower front corners of the headlight pod.
2. Remove the screw from the rear of the pod.
3. Lift the pod slightly while depressing the tabs at the rear of the pod.
4. Lift the pod cover and disconnect the speedometer harnesses from the speedometer.

**CAUTION!** Hot components can cause burns to skin. Allow lamps to cool before servicing.

5. Unplug the headlamp from the wiring harness. Be sure to pull on the connector, not on the wiring.
6. Turn the lamp counter-clockwise to remove it.
7. Apply dielectric grease to the socket and install the new lamp. Make sure the tab on the lamp locates properly in the housing.
8. Reassemble the pod.

## Lights

### High Beam Adjustment

The headlight beam can be adjusted slightly upward or downward. Use the following procedure to make the adjustment.

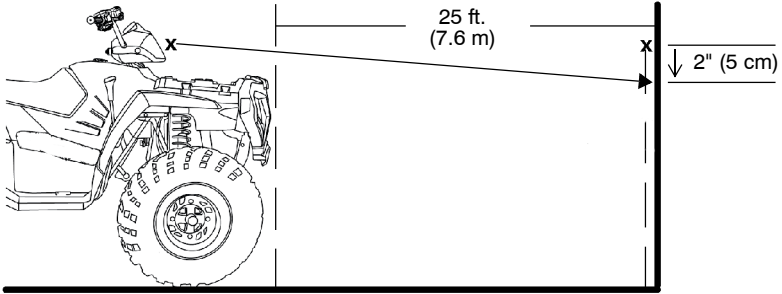

1. Position the vehicle on a level surface with the headlight approximately 25 ft. (7.6 m) from a wall. Place the transmission in PARK.
2. Measure the distance from the floor to the center of the headlight and make a mark on the wall at the same height.
3. Start the engine. Turn the headlight switch to high beam.
4. Observe the headlight aim on the wall. The most intense part of the headlight beam should be two inches (5 cm) below the mark on the wall. Include rider weight on the seat when measuring.
5. The adjustment knob is located on the right side of the headlight pod. Adjust the beam to the desired position by turning the knob either clockwise or counter-clockwise.

### Low Beam Adjustment

The low beam can be adjusted slightly upward or downward.

1. Loosen the phillips screw located at the rear of the headlamp.
2. Tilt the headlamp upward or downward.
3. Tighten the screw.

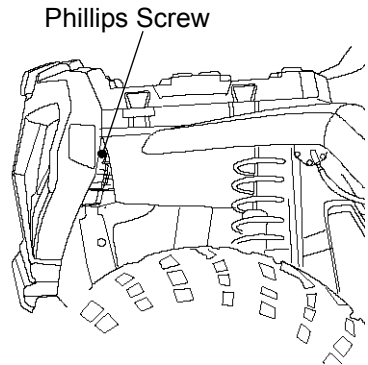

# MAINTENANCE

## Lights

### Headlight Housing Replacement

1. Remove the two screws on the lower front corners of the headlight pod.
2. Lift the pod slightly while depressing the tabs at the rear of the pod.
3. Lift the pod cover and disconnect the speedometer harnesses from the speedometer.
4. Unplug the headlamp from the wiring harness.
5. Use a small screwdriver to remove the o-rings from the headlight mounting tabs.
6. Pull the headlight housing up to release it from the locking tabs.
7. Lift the adjusting knob up to remove it from the locking tabs.
8. Carefully pull the assembly up and out of the pod.
9. Reverse the steps to install the new housing and reassemble the pod. The distance from the headlamp parting line to the end of the adjustment knob stop is  $5 \frac{1}{8}$ " (13 cm).
10. Adjust the headlight aim by turning the adjusting knob.

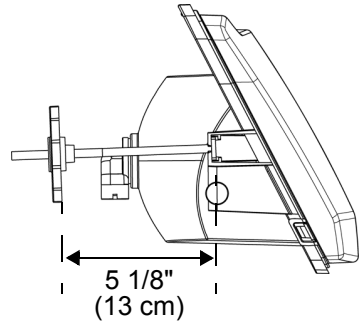

## Lights

### Lower Headlamp Replacement

1. Turn the back of the headlight harness counter-clockwise and pull the harness assembly away from the headlight assembly.
2. Remove the headlamp and install the new headlamp.
3. Reinstall the harness assembly into the headlight assembly.
4. Turn the headlight harness clockwise to secure the headlamp.

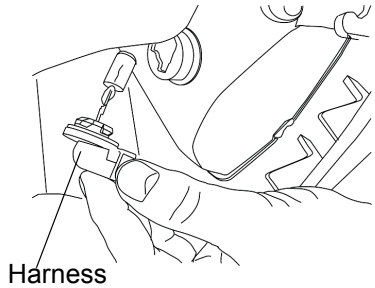

### Taillight/Brakelight Lamp Replacement

1. Remove the harness connector from the back of the light assembly.
2. Turn the lamp counter-clockwise to remove it.
3. Apply dielectric grease to the socket and install the new lamp.
4. Reinstall the harness connector.
5. Test the light for proper operation.

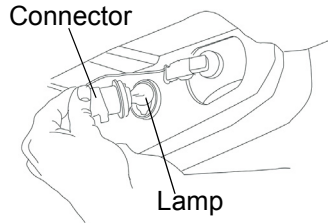

# MAINTENANCE

## Spark Plugs

### Spark Plug Recommendations

Refer to the specifications section beginning on page 118 for the recommended spark plug type and gap for your vehicle. Torque spark plugs to specification.

**NOTICE:** Using non-recommended spark plugs can result in serious engine damage. Always use Polaris-recommended spark plugs.

Plug Condition	Torque Specification
New Spark Plug	9-11 ft. lbs. (12-15 Nm)
Previously Installed Spark Plug	17-20 ft. lbs. (23-27 Nm)

### Spark Plug Inspection

Spark plug condition is indicative of engine operation. Check the spark plug firing end condition after the engine has been warmed up and the vehicle has been driven at higher speeds. Immediately check the spark plug for correct color. See page 91.

**CAUTION!** A hot exhaust system and engine can cause burns. Wear protective gloves when removing a spark plug for inspection.

1. Rotate the spark plug cap 1/4 turn and pull it off the spark plug.
2. Using the special wrench provided in the tool pouch, rotate the spark plug counter-clockwise to remove it.
3. Reverse the procedure for spark plug installation. Torque to specification.

## **Spark Plugs**

### **Spark Plug Inspection**

#### **Normal Spark Plug**

The normal insulator tip is gray, tan or light brown. There will be few combustion deposits. The electrodes are not burned or eroded. This indicates the proper type and heat range for the engine and the service.

The tip should not be flaky and white. A white insulator tip indicates overheating, caused by use of an improper spark plug or incorrect carburetion adjustments.

#### **Wet Fouled Spark Plug**

The wet fouled insulator tip is black. A damp oil film covers the firing end. There may be a carbon layer over the entire nose. Generally, the electrodes are not worn. General causes of fouling are excessive oil, use of non-recommended oil, improper use of the choke, or incorrect throttle body/carburetor adjustments.

# MAINTENANCE

## Vehicle Immersion

If your vehicle becomes immersed, major engine damage can result if the machine is not thoroughly inspected. Take the vehicle to your dealer before starting the engine. If it's impossible to take your ATV to a dealer before starting it, follow the steps outlined below.

1. Move the ATV to dry land or at the very least, to water below the footrests.
2. Check the air box. If water is present, dry the air box and replace the filter with a new filter.
3. Turn the fuel valve off.
4. Remove the spark plug.
5. Loosen the carburetor drain screw.
6. Turn the engine over several times using the electric start.
7. Dry the spark plug. Reinstall the plug or install a new plug.
8. Tighten the carburetor drain screw.
9. Turn the fuel valve on.
10. Attempt to start the engine. If necessary, repeat the drying procedure.
11. Take the ATV to your dealer for service as soon as possible, whether you succeed in starting it or not.
12. If water has been ingested into the PVT, follow the procedure on page 96 for drying out the PVT.

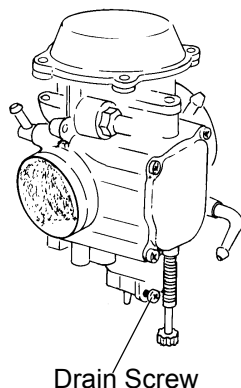



## Spark Arrestor

### **⚠ WARNING**

Failure to heed the following warnings while servicing the spark arrestor could result in serious injury or death. Never run the engine in an enclosed area. Remove any combustible materials from the area. Wear eye protection and leather work gloves. Do not stand behind or in front of the vehicle while purging. Never go under the vehicle while it's inclined.

The exhaust system can get extremely hot. Do not perform service on the spark arrestor while the system is hot. Allow components to cool sufficiently before proceeding.

Use the following procedure to periodically purge accumulated carbon from the exhaust pipe/muffler.

1. Remove the arrestor clean-out plug from the bottom of the muffler.
2. Place the transmission in PARK.
3. Start the engine.
4. Quickly squeeze and release the throttle lever several times to purge carbon from the system.
5. If carbon comes out of the exhaust, cover or plug the exhaust outlet. Wear protective gloves.
6. Lightly tap on the exhaust pipe with a rubber mallet while repeating step 4.
7. If particles are still suspected to be in the muffler, elevate the rear of the vehicle one foot (30 cm) higher than the front. Block the wheels.
8. Repeat steps 4 to 6 until no more particles are expelled.
9. Stop the engine. Allow the arrestor to cool.
10. Reinstall the arrestor plug and remove the exhaust outlet cover or plug.

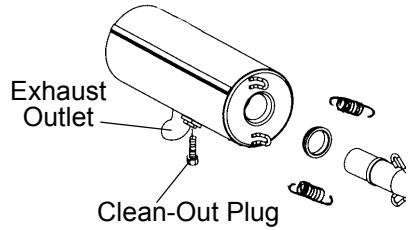

# MAINTENANCE

## PVT System

### **WARNING**

Failure to comply with the instructions in this warning can result in severe injury or death.

Do not modify any component of the PVT system. Doing so may reduce its strength so that a failure may occur at a high speed. The PVT system has been precision balanced. Any modification will cause the system to be out of balance, creating vibration and additional loads on components.

The PVT system rotates at high speeds, creating large amounts of force on clutch components. Extensive engineering and testing has been conducted to ensure the safety of this product. However, as the owner, you have the following responsibilities to make sure this system remains safe:

- Always follow all recommended maintenance procedures. See your dealer as outlined in the owner's manual.
- This PVT system is intended for use on Polaris products only. Do not install it in any other product.
- Always make sure the PVT housing is securely in place during operation.

## PVT System

The basic operation of the Polaris PVT system is dependent on engine speed and vehicle torque requirements. As engine speed increases, the force exerted on the movable drive sheave by the flyweights also increases. This, in turn, increases the amount of pinch applied to the drive belt. Similarly, if the engine speed decreases, the amount of centrifugal force decreases, reducing the amount of belt pinch.

On Polaris ATVs, the approximate gear ratio difference between high and low range is 1:2.25. This difference in gearing affects the operation of the PVT, especially at speeds less than 7 MPH (11 km/h), due to the system's dependence on engine speed.

For example, when operating at a ground speed of 3 MPH (5 km/h) in low range, the engine speed would be around 3000 RPM. This is well above the engagement speed of 1200 - 1400 RPM. However, in high range at 3 MPH (5 km/h), the engine would be running at only 1500 RPM. Whenever operating this close to the engagement speed, the engine may be running at a speed too low to provide the pinch needed to prevent belt slip. Belt slip is responsible for creating the excessive heat that destroys belts, wears clutch components and causes outer clutch covers to fail.

The air temperature in the clutch cover is substantially reduced by using low range while operating at low ground speeds. Reducing the temperature inside the clutch cover greatly extends the life of the PVT components (belt, cover, etc.).

# MAINTENANCE

## PVT System

### When To Use Low Range and High Range

Condition	Range to Use
Operating at speeds less than 7 MPH (11 km/h)	Low
Towing heavy loads	Low
Operating in rough terrain (swamps, mountains, etc.)	Low
Operating at speeds greater than 7 MPH (11 km/h)	High

### PVT Drying

There may be some instances when water is accidentally ingested into the PVT system. Use the following instructions to dry it out before operating.

1. Position the vehicle on a level surface.
2. Remove the drain plug. Allow the water to drain completely. Reinstall the drain plug.
3. Start the engine. Place the transmission in PARK.
4. Apply varying throttle for 10-15 seconds to expel the moisture and air-dry the belt and clutches. Do not hold the throttle wide open for more than 10 seconds.
5. Allow the engine RPM to settle to idle speed, then shift the transmission to the lowest available range.
6. Test for belt slippage. If the belt slips, repeat the process.
7. Take the vehicle to your dealer for service as soon as possible.

## Battery

### **⚠ WARNING**

Improperly connecting or disconnecting battery cables can result in an explosion and cause serious injury or death. When removing the battery, always disconnect the negative (black) cable first. When reinstalling the battery, always connect the negative (black) cable last.

### **⚠ WARNING**

Battery electrolyte is poisonous. It contains sulfuric acid. Serious burns can result from contact with skin, eyes or clothing.

Antidote:

**External:** Flush with water.

**Internal:** Drink large quantities of water or milk. Follow with milk of magnesia, beaten egg, or vegetable oil. Call physician immediately.

**Eyes:** Flush with water for 15 minutes and get prompt medical attention.

Batteries produce explosive gases. Keep sparks, flame, cigarettes, etc. away. Ventilate when charging or using in an enclosed space. Always shield eyes when working near batteries. **KEEP OUT OF REACH OF CHILDREN.**

Your ATV may have either a sealed battery, which requires little maintenance, or a conventional battery. A sealed battery can be identified by its flat covers on the top of the battery. A conventional battery has six filler caps on the top of the battery.

Always keep battery terminals and connections free of corrosion. If cleaning is necessary, remove corrosion with a stiff wire brush. Wash with a solution of one tablespoon baking soda and one cup water. Rinse well with tap water and dry off with clean shop towels. Coat the terminals with dielectric grease or petroleum jelly. Be careful not to allow cleaning solution or tap water into a conventional battery.

# MAINTENANCE

## Battery

### Battery Removal

1. Disconnect the battery hold-down strap.
2. Remove the battery cover.
3. On conventional batteries, remove the battery vent tube.
4. Disconnect the black (negative) battery cable first.
5. Disconnect the red (positive) battery cable last.
6. Lift the battery out of the ATV. Be careful not to tip a conventional battery sideways, which could spill electrolyte.

**NOTICE:** If electrolyte spills, immediately wash it off with a solution of one tablespoon baking soda and one cup water to prevent damage to the vehicle.

## Battery

### Battery Installation

Using a new battery that has not been fully charged can damage the battery and result in a shorter life. It can also hinder vehicle performance. Follow the battery charging instructions on page 101 before installing the battery.

1. Ensure that the battery is fully charged.
2. Place the battery in the battery holder.
3. With conventional batteries, install the battery vent tube (sealed batteries do not have a vent tube). The vent tube must be free of obstructions and securely installed. Route the tube away from the frame and vehicle body to prevent contact with electrolyte.

**WARNING!** Battery gases could accumulate in an improperly installed vent tube and cause an explosion, resulting in serious injury or death. Always ensure that the vent tube is free of obstructions and is securely installed as recommended.

4. On conventional batteries, coat the terminals with dielectric grease or petroleum jelly.
5. Connect and tighten the red (positive) cable first.
6. Connect and tighten the black (negative) cable last.
7. Install the battery cover.
8. Secure the battery hold-down strap.
9. Verify that cables are properly routed. Cables should be safely tucked away at the front and rear of the battery.

# MAINTENANCE

## Battery

### Battery Storage

Whenever the vehicle is not used for a period of three months or more, remove the battery from the vehicle, ensure that it's fully charged, and store it out of the sun in a cool, dry place. Check battery voltage each month during storage and recharge as needed to maintain a full charge.

**Tip:** Power plug leads may need to be bent down so that the battery cover can be installed.

Polaris recommends maintaining battery charge by using a Polaris Battery Tender charger or by charging about once a month to make up for normal self-discharge. Battery Tender can be left connected during the storage period, and will automatically charge the battery if the voltage drops below a pre-determined point. See page 117 for the part numbers of Polaris products.

### Battery Fluid (Conventional Battery)

A poorly maintained battery will deteriorate rapidly. Check the battery fluid level often. Maintain the fluid level between the upper and lower level marks.

Add only distilled water. Tap water contains minerals that are harmful to a battery.

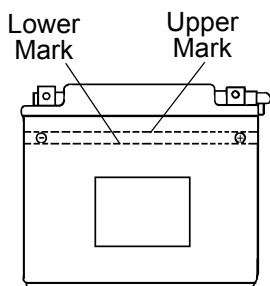



## Battery

### Battery Charging (Conventional Battery)

1. Remove the battery from the vehicle to prevent damage from leaking or spilled electrolyte during charging. See page 98.
2. Charge the battery with a charging output no larger than 1/10 of the battery's amp/hr rating. Charge as needed to raise the specific gravity to 1.270 or greater.
3. Reinstall the battery. See page 99. Make sure the positive terminal is toward the front of the vehicle.

### Battery Charging (Sealed Battery)

The following battery charging instructions apply only to the installation of a sealed battery. Read all instructions before proceeding with the installation of this battery.

The sealed battery is already filled with electrolyte and has been sealed and *fully charged* at the factory. *Never* pry the sealing strip off or add any other fluid to this battery.

The single most important thing about maintaining a sealed battery is to keep it fully charged. Since the battery is sealed and the sealing strip cannot be removed, you must use a voltmeter or multimeter to measure DC voltage.

**WARNING!** An overheated battery may explode, causing severe injury or death. Always watch charging times carefully. Stop charging if the battery becomes very warm to the touch. Allow it to cool before resuming charging.

For a refresh charge, follow all instructions carefully.

1. Check the battery voltage with a voltmeter or multimeter. A fully charged battery will register 12.8 V or higher.
2. If the voltage is less than 12.8 volts, recharge the battery at 1.2 amps or less until battery voltage is 12.8 or greater.
3. When using an automatic charger, refer to the charger manufacturer's instructions for recharging. When using a constant current charger, use the guidelines on the next page for recharging.

# MAINTENANCE

## Battery

### Battery Charging (Sealed Battery)

Always verify battery condition before and 1-2 hours after the end of charging.

<b>State of Charge</b>	<b>Voltage</b>	<b>Action</b>	<b>Charge Time</b> (Using constant current charger @ standard amps specified on top of battery)
100%	12.8-13.0 volts	None, check at 3 mos. from date of manufacture	None required
75%-100%	12.5-12.8 volts	May need slight charge, if no charge given, check in 3 months	3-6 hours
50%-75%	12.0-12.5 volts	Needs charge	5-11 hours
25%-50%	11.5-12.0 volts	Needs charge	At least 13 hours, verify state of charge
0%-25%	11.5 volts or less	Needs charge with desulfating charger	At least 20 hours

## Camber and Caster

The camber and caster are non-adjustable.

## Rear Spring

The rear shock absorber spring is adjusted by rotating the adjuster either clockwise or counter-clockwise to increase or decrease spring tension.

Accessory springs are available through your Polaris dealer.

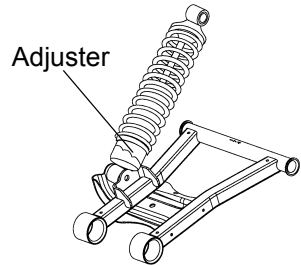

## Handlebars

The handlebars can be adjusted for rider preference.

**WARNING!** Improper adjustment of the handlebars or incorrect torquing of the adjuster block tightening bolts can cause limited steering or loosening of the handlebars, resulting in loss of control and serious injury or death. Follow the adjustment procedures exactly, or see your Polaris dealer for service.

1. Remove the upper headlight pod.
2. Loosen the four handlebar bolts.
3. Adjust the handlebar to the desired height.
4. Be sure the handlebars do not contact the gas tank or any other part of the machine when turned fully to the left or right.
5. Torque the front two bolts to 10-12 ft. lbs. (14-17 Nm), then torque the rear two bolts. A gap of up to 1/8" (3 mm) will remain at the rear of the clamp blocks.

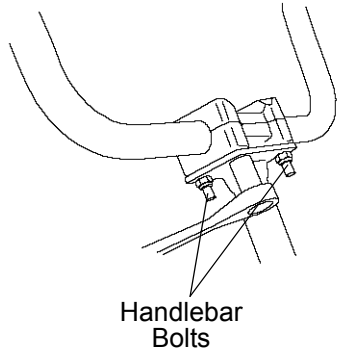

# MAINTENANCE

## Carburetor

Your Polaris ATV is calibrated at the factory for optimal performance at altitudes ranging from zero to 6,000 feet (1800 m) and temperatures of +40 degrees F. (4 degrees C.) or higher. Above 6000 feet (1800 m) the engine air/fuel mixture becomes overly rich and the engine loses approximately 3% of its power for each 1000-foot (304.8 m) increase in elevation. Although this power cannot be regained, adjustments to the carburetor and drive system can be made to allow more efficient operation. Optional jets, available from your Polaris dealer, are required for operation above 6,000 feet and temperatures below +40 degrees F. (4 degrees C.)

Continuous operation of the engine without proper jetting when required can cause poor performance, overheating or PVT or engine damage. See your Polaris dealer for more information about jetting the ATV for conditions in your area.

Pilot screws are sealed with metal plugs and are serviceable only by Polaris dealers.

## Carburetor/Engine Idle RPM Adjustment

Recommended engine idle RPM is 1200 +/- 200. If the engine idle speed is unsatisfactory and all other conditions are favorable, the carburetor can be adjusted.

1. Start the engine and allow it to warm up for approximately five minutes.
2. Place the transmission in gear.
3. Lock the parking brake.
4. Turn the screw in (clockwise) to raise RPM. Turn the screw out (counter-clockwise) to lower RPM.

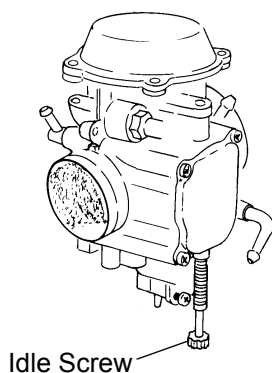

## Throttle Cable Freeplay

Adjust throttle cable freeplay at the handlebar.

1. Locate the throttle cable adjuster at the handlebar.
2. Squeeze the end of the rubber boot and slide it far enough to expose the end of the inline cable adjuster.
3. Loosen the adjuster lock nut.
4. Rotate the boot to turn the adjuster until  $1/16''$  to  $1/8''$  (1.5-3 mm) of freeplay is achieved at the thumb lever. While adjusting freeplay, be sure to flip the throttle lever back and forth.
5. Tighten the lock nut.
6. Squeeze the end of the rubber boot and slide it over the cable adjuster to its original position.

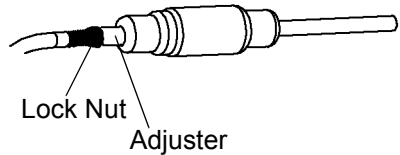
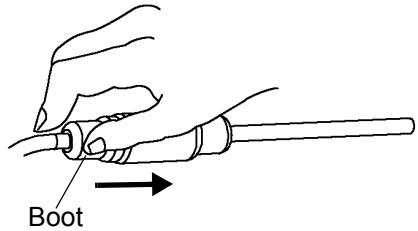
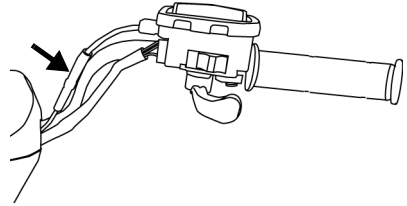

# MAINTENANCE

## Cleaning and Storage

### Washing the Vehicle

Keeping your Polaris vehicle clean will not only improve its appearance but it can also extend the life of various components.

**NOTICE:** High water pressure may damage components. Polaris recommends washing the vehicle by hand or with a garden hose, using mild soap.

Certain products, including insect repellents and chemicals, will damage plastic surfaces. Do not allow these types of products to contact the vehicle.

The best and safest way to clean your Polaris vehicle is with a garden hose and a pail of mild soap and water.

1. Use a professional-type washing cloth, cleaning the upper body first and the lower parts last.
2. Rinse with clean water frequently.
3. Dry surfaces with a chamois to prevent water spots.

### Washing Tips

- Avoid the use of harsh cleaners, which can scratch the finish.
- Do not use a power washer to clean the vehicle.
- Do not use medium to heavy duty compounds on the finish.
- Always use clean cloths and pads for cleaning and polishing. Old or reused cloths and pads may contain dirt particles that will scratch the finish.

## Cleaning and Storage

### Washing the Vehicle

If a high pressure water system is used for cleaning (not recommended), exercise extreme caution. The water may damage components and could remove paint and decals. Avoid directing the water stream at the following items:

- Wheel bearings
- Radiator
- Transmission seals
- Brakes
- Cab and body panels
- Electrical components
- Switches and controls
- Labels and decals

If an informational or graphic label becomes illegible or comes off, contact your Polaris dealer to purchase a replacement. Replacement *safety* labels are provided by Polaris at no charge.

Grease all zerk fittings immediately after washing. Allow the engine to run for a while to evaporate any water that may have entered the engine or exhaust system.

### Polishing the Vehicle

Polaris recommends the use of common household aerosol furniture polish for polishing the finish on your Polaris vehicle. Follow the instructions on the container.

#### Polishing Tips

- Avoid the use of automotive products, some of which can scratch the finish of your vehicle.
- Always use clean cloths and pads for cleaning and polishing. Old or reused cloths and pads may contain dirt particles that will scratch the finish.

# **MAINTENANCE**

## **Cleaning and Storage**

### **Chrome Wheel Care (if equipped)**

Proper maintenance will protect chrome wheels from corrosion, preserve wheel life and ensure a "like new" appearance for many years. Chrome wheels exposed to road salt (or salt in the air in coastal areas) are more susceptible to corrosion if not properly cleaned. Clean chrome wheels more often if they're exposed to salt or other corrosive elements.

1. Wash chrome wheels frequently. Use a mild detergent. Never use abrasive cleaners on plated or painted surfaces.
2. Rinse well with clear water. Soap, detergents, salt, dirt, mud and other elements can cause corrosion.
3. Polish the clean chrome wheels periodically. Use an automotive grade chrome polish.
4. Routinely and liberally apply a weather resistant wax to each polished chrome wheel. Choose a product suitable for chrome finishes. Read and follow the product labels and instructions.

### **Removing Corrosion**

If light rust is found on the chrome finish, use steel wool (#0000-OTT grade) to remove it. Gently rub the affected areas with the steel wool until the corrosion has been removed. Clean and polish the wheel as outlined above.



## Cleaning and Storage

### Storage Tips

**NOTICE:** Starting the engine during the storage period will disturb the protective film created by fogging and damage could occur. Never start the engine during the storage period.

### Clean the Exterior

Make any necessary repairs and clean the vehicle as recommended. See page 106.

### Stabilize the Fuel

1. Fill the fuel tank.
2. Add Polaris Carbon Clean Fuel Treatment or Polaris Fuel Stabilizer. Follow the instructions on the container for the recommended amount. Carbon Clean removes water from fuel systems, stabilizes fuel and removes carbon deposits from pistons, rings, valves and exhaust systems.
3. Allow the engine to run for 15-20 minutes to allow the stabilizer to disperse through the fuel in the tank and carburetor.
4. Turn the fuel valve off.
5. Drain the carburetor bowl.

### Oil and Filter

Change the oil and filter. See page 70.

### Air Filter / Air Box

1. Inspect and clean (or replace) the pre-cleaner and air filter. See page 83.
2. Clean the air box.
3. Drain the sediment tube.
4. Clean or replace the breather filter. See page 84.

# MAINTENANCE

## Cleaning and Storage

### Storage Tips

#### Fluid Levels

Inspect the fluid levels. Add or change fluids as recommended in the Periodic Maintenance Chart beginning on page 62.

- Demand drive unit (front gearcase)
- Rear gearcase (if equipped)
- Transmission
- Brake fluid (change every two years and any time the fluid looks dark or contaminated)
- Coolant (test strength/fill)

#### Fog the Engine

1. Support the front end of the machine so the engine is level or tilted slightly rearward.
2. Remove the spark plug. Rotate the piston to BDC and pour two ounces (59 ml) of Premium 4 Synthetic 0W40 engine oil into the cylinder.
3. Reinstall the spark plug. Torque to specification.
4. Apply dielectric grease to the inside of the spark plug cap. Reinstall the cap.
5. Turn the engine over several times using the recoil starter. Oil will be forced in and around the piston rings and ring lands, coating the cylinder with a protective film of fresh oil.
6. Treat the fuel system with Polaris Carbon Clean. See page 109.
7. If Polaris fuel system additive is not used, the fuel tank, fuel lines, and carburetor should be completely drained of gasoline.
8. To eliminate any fuel remaining in the carburetor, run the engine until it stops.

## **Cleaning and Storage**

### **Storage Tips**

#### **Inspect and Lubricate**

Inspect all cables and lubricate all areas of the vehicle as recommended in the Periodic Maintenance Chart beginning on page 62.

#### **Battery Storage**

See pages 100-101 for storage and charging procedures.

#### **Storage Area/Covers**

Set the tire pressure and safely support the ATV with the tires slightly off the ground. Be sure the storage area is well ventilated. Cover the vehicle with a genuine Polaris cover. Do not use plastic or coated materials. They do not allow enough ventilation to prevent condensation, and may promote corrosion and oxidation.

### **Accessories**

Auxiliary power outlets provide 12-volt power for operating accessories. Accessory outlets are available for all models. Polaris also has a wide range of additional accessories available for your ATV. Always install accessories that are approved for ATV use. Please see your Polaris dealer.

# MAINTENANCE

## Transporting the ATV

Follow these procedures when transporting the vehicle.

1. Stop the engine.
2. Place the transmission in PARK.
3. Lock the parking brake.
4. Secure the fuel cap, oil cap and seat.
5. Always tie the frame of the ATV to the transporting unit securely with suitable straps or rope. Do not attach tie straps to the front A-arm bolt pockets, racks or handlebars.
6. Remove the key to prevent loss during transporting.

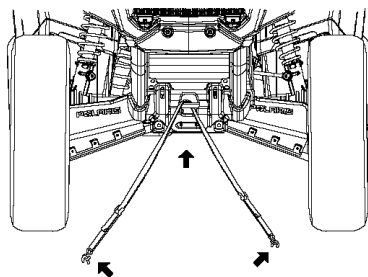
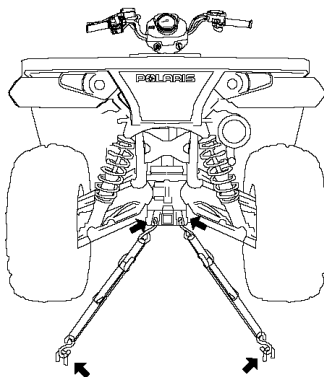

# TROUBLESHOOTING

## Drive Belt Wear/Burn

Possible Cause	Solution
Driving onto a pickup or tall trailer in high range	Use low range during loading.
Starting out going up a steep incline	Use low range or turn around using the K-turn (see page 54).
Driving at low RPM or ground speed (3-7 MPH)	Drive at a higher speed or use low range more frequently. See page 96.
Insufficient warm-up at low ambient temperatures	Warm the engine at least 5 minutes. With the transmission in neutral, advance the throttle to about 1/8 throttle in short bursts, 5 to 7 times. The belt will become more flexible and prevent belt burning.
Slow/easy clutch engagement	Use the throttle quickly and effectively.
Towing/pushing at low RPM/low ground speed	Use low range only.
Utility use/plowing	Use low range only.
Stuck in mud or snow	Shift the transmission to low range and carefully use fast, aggressive throttle application to engage clutch. <b>WARNING!</b> Excessive throttle may cause loss of control and vehicle overturn.
Climbing over large objects from a stopped position	Shift the transmission to low range and carefully use fast, brief, aggressive throttle application to engage clutch. <b>WARNING!</b> Excessive throttle may cause loss of control and vehicle overturn.
Belt slippage from water or snow ingestion into the PVT system	Dry out the PVT. See page 96. Inspect clutch seals for damage if repeated leaking occurs.
Clutch malfunction	See your Polaris dealer.
Poor engine performance	Check for fouled plugs or foreign material in gas tank or fuel lines. See your dealer.
Slippage from failure to warm up belt	Always warm up the belt by operating below 30 mph for one mile (5 miles or more when temperature is below freezing).
Wrong or missing belt	Install the recommended belt.
Improper break-in	Always break in a new belt and/or clutch. See page 42.

# TROUBLESHOOTING

## Engine Doesn't Turn Over

Possible Cause	Solution
Tripped circuit breaker	Reset the breaker
Low battery voltage	Recharge the battery to 12.8 VDC
Loose battery connections	Check all connections and tighten
Loose solenoid connections	Check all connections and tighten

## Engine Turns Over, Fails to Start

Possible Cause	Solution
Out of fuel	Refuel
Clogged fuel valve or filter	Inspect and clean or replace
Water is present in fuel	Drain the fuel system and refuel
Old or non-recommended fuel	Replace with fresh recommended fuel
Fuel valve is turned off	Turn the fuel valve on
Fouled or defective spark plug(s)	Inspect plugs and replace if necessary
No spark to spark plug	Inspect plugs, verify stop switch is on
Water or fuel in crankcase	Immediately see your Polaris dealer
Overuse of choke	Inspect, clean and/or replace spark plugs
Low battery voltage	Recharge the battery to 12.8 VDC
Mechanical failure	See your dealer

## Engine Backfires

Possible Cause	Solution
Weak spark from spark plug	Inspect, clean and/or replace spark plugs
Incorrect spark plug gap or heat range	Set gap to specs or replace plugs
Old or non-recommended fuel	Replace with fresh recommended fuel
Incorrectly installed spark plug wires	See your dealer
Incorrect ignition timing	See your dealer
Mechanical failure	See your dealer
Loose ignition connections	Check all connections and tighten
Water present in fuel	Replace with fresh recommended fuel

# TROUBLESHOOTING

## Engine Pings or Knocks

Possible Cause	Solution
Poor quality or low octane fuel	Replace with recommended fuel
Incorrect ignition timing	See your dealer
Incorrect spark plug gap or heat range	Set gap to specs or replace plugs

## Engine Runs Irregularly, Stalls or Misfires

Possible Cause	Solution
Fouled or defective spark plug(s)	Inspect, clean and/or replace spark plug(s)
Worn or defective spark plug wires	See your dealer
Incorrect spark plug gap or heat range	Set gap to specs or replace plugs
Loose ignition connections	Check all connections and tighten
Water present in fuel	Replace with new fuel
Low battery voltage	Recharge battery to 12.8 VDC
Kinked or plugged fuel tank vent line	Inspect and replace
Incorrect fuel	Replace with recommended fuel
Clogged air filter	Inspect and clean or replace
Reverse speed limiter malfunction	See your dealer
Electronic throttle control malfunction	See your dealer
Other mechanical failure	See your dealer

Possible Lean Fuel Cause	Solution
Low or contaminated fuel	Add or change fuel, clean the fuel system
Kinked or plugged fuel tank vent line	Inspect and replace
Low octane fuel	Replace with recommended fuel
Clogged fuel filter	Replace filter
Incorrect fuel	Replace with recommended fuel
Incorrect jetting	See your Polaris dealer

Possible Rich Fuel Cause	Solution
Fuel is very high octane	Replace with lower octane fuel
Overuse of choke	Inspect, clean and/or replace spark plugs
Stopping/starting without adequate warm-up	Allow engine to warm up before operating and/or stopping
Incorrect fuel	Replace with recommended fuel
Clogged air filter	Inspect and clean or replace
Incorrect jetting	See your Polaris dealer

# TROUBLESHOOTING

## Engine Stops or Loses Power

Possible Cause	Solution
Out of fuel	Refuel, cycle key to ON position three times for 5 seconds each, then start
Kinked or plugged fuel vent line	Inspect and replace
Overuse of choke	Inspect, clean and/or replace spark plugs
Water is present in fuel	Replace with new fuel
Fouled or defective spark plug(s)	Inspect, clean and/or replace spark plug(s)
Worn or defective spark plug wires	See your dealer
Incorrect spark plug gap or heat range	Set gap to specs or replace plug
Loose ignition connections	Check all connections and tighten
Low battery voltage	Recharge the battery to 12.8 VDC
Incorrect fuel	Replace with fresh recommended fuel
Clogged air filter	Inspect and clean or replace
Reverse speed limiter malfunction	See your dealer
Electronic throttle control malfunction	See your dealer
Other mechanical failure	See your dealer
Overheated engine	Clean radiator screen and core, clean engine exterior, see your dealer

## Engine Overheating

Possible Cause	Solution
Debris lodged in screen	Remove and clean the screen. Pull on the top portion of the screen, then remove the lower portion.
Plugged Radiator	Use a garden hose to flush any debris from the radiator fins. NOTE: High pressure washers can deform the radiator fins and reduce cooling efficiency.
Obstructed cooling fan	Clean any debris or mud that may be interfering with fan movement.



# POLARIS PRODUCTS

<b>Part Number</b>	<b>Description</b>
<b>Engine Lubricant</b>	
2870791	Fogging Oil (12 oz. Aerosol)
2871281	Premium 4 Synthetic 0W-40 (4-Cycle) Engine Oil (qt./95 l)
2871844	Premium 4 Synthetic 0W-40 (4-Cycle) Engine Oil (gal./3.8 l)
<b>Gearcase / Transmission Lubricants</b>	
2873602	Premium AGL Synthetic Gearcase Lubricant (qt./95 l)
2873603	Premium AGL Synthetic Gearcase Lube (gal./3.8 l)
2877922	Demand Drive Plus Fluid (qt./95 l)
2877923	Demand Drive Plus Fluid (gal./3.8 l)
2870465	Pump for Gallon (3.8 l) Jug
2871654	Premium Demand Drive Hub Fluid (237 ml)
2872277	Premium Demand Drive Hub Fluid (9.5 l)
<b>Coolant</b>	
2871323	60/40 Coolant (gal./3.8 l)
2871534	60/40 Coolant (qt./95 l)
<b>Grease / Specialized Lubricants</b>	
2871312	Grease Gun Kit, Premium All Season
2871322	Premium All Season Grease (3 oz./89 ml cartridge)
2871423	Premium All Season Grease (14 oz./414 ml cartridge)
2871460	Starter Drive Grease
2871515	Premium U-Joint Lube (3 oz./89 ml cartridge)
2871551	Premium U-Joint Lube (14 oz./414 ml cartridge)
2871329	Dielectric Grease (Nyogel™)
2872073	Chain Lube, Aerosol (6.25 oz./185 ml)
2872348	Chain Lube, Aerosol (16 oz./473 ml)
<b>Additives / Miscellaneous</b>	
2871326	Carbon Clean Plus
2870652	Fuel Stabilizer
2872189	DOT 4 Brake Fluid
2871956	Loctite™ 565 Thread Sealant
2859044	Polaris Battery Tender™ Charger

# SPECIFICATIONS

<b>Sportsman 500</b>	
Gross Vehicle Weight	1200 lbs. (544 kg)
Maximum Weight Capacity	485 lbs. (220 kg) (operator, cargo, accessories)
Dry Weight	696 lbs. (316 kg)
Fuel Capacity	4.25 gal. (16 l)
Engine Oil Capacity	2 qts. (1.9 l)
Transmission Oil Capacity	32 oz. (948 ml)
Demand Drive Fluid Capacity	9 oz. (265 ml)
Coolant Capacity	2.7 qts. (2.5 l)
Front Rack/Storage Box Capacity	90 lbs. (40.8 kg)
Rear Rack/Storage Box Capacity	180 lbs. (81.6 kg)
Receiver Hitch Tongue Capacity	120 lbs. (54 kg) (Rear rack capacity and tongue weight not to exceed 180 lbs./81.6 kg)
Hitch Towing Rating	1225 lbs. (555.7 kg)
Unbraked Trailer Towing Capacity*	1786 lbs. (810 kg)
Overall Length	83 in. (211 cm)
Overall Width	48 in. (122 cm)
Overall Height	48 in. (122 cm)
Wheelbase	50.5 in. (128.3 cm)
Ground Clearance	11 in. (28 cm)
Minimum Turning Radius	65 in. (165 cm) unloaded
Engine	EH500PLE
Displacement	498 cc
Bore x Stroke	92 x 75
Alternator Output	260 w
Compression Ratio	10.2:1
Carburetor	40mm Mikuni
Pilot Jet	40
Main Jet	155
Needle Jet	X-6M
Jet Needle	6MGHI 194
Pilot Screw	By flow (taper 12.5°) (Brass Plug)
Ignition System	Digital CDI
Ignition Timing	30° +/- 2° @ 5000 RPM
Spark Plug / Gap	NGK BKR6E / .035 in. (0.9 mm)
Lubrication System	Dry Sump

\* Based on EU Directive 76/432/EC

# SPECIFICATIONS

## Sportsman 500

Driving System Type	Automatic PVT (Polaris Variable Transmission)
Front Suspension	MacPherson strut with 8.2" (21 cm) travel
Rear Suspension	Progressive rate with 9.5" (24 cm) travel
Shift Type	Side Lever (H/L/N/R/P)
Gear Reduction, Low	23.91:1
Gear Reduction, Reverse	16.30:1
Gear Reduction, Forward	10.49:1
Drive Ratio, Front	3.82:1
Tires/Pressure, Front	25x8-12 / 5 psi
Tires/Pressure, Rear	25x11-12 / 5 psi
Brakes, Front	Single-Control Hydraulic Disc
Brakes, Rear	Single-Control Hydraulic Disc
Brake, Auxiliary	Foot-Activated Hydraulic Disc
Brake, Parking	Hydraulic lock, all wheel
Headlight	1 Single Beam on Headlight Pod (50 watt) 2 Single Beam on Bumper (37.5 watt)
Taillights	8.26 watts
Brake Light	26.9 watts
Instrument Cluster	LCD

## Jetting Chart

ALTITUDE Meters (Feet)	AMBIENT TEMPERATURE	
	Below 40° F (Below 5° C)	+40°F and above (+5°C and above)
0-1800 (0-6000)	160	155
1800-3700 (6000-12000)	152.5	147.5

## Clutching Chart

Altitude		Shift Weight	Drive Clutch Spring	Driven Clutch Spring	Helix and Spring Setting
Meters (Feet)	0-1800 (0-6000)	10 WH PN 5630710	Blue/Green PN 7041157	Black PN 7041782	41-37° PN 5132344 2+2
	1800-3700 (6000-12000)	10 RH PN 5630709	Blue/Green PN 7041157	Black PN 7041782	41-37° PN 5132344 2+2

# DECLARATION OF CONFORMITY

Polaris Industries Inc.,  
2100 Hwy 55, Medina, MN 55340 U.S.A.  
Telephone 763-542-0500



We, Polaris Industries Inc., declare that the vehicles listed below conform to the essential health and safety requirements applicable to off-road all-terrain vehicles.

APPLICABLE EUROPEAN DIRECTIVES	TEST / EVALUATION METHODS	
98/37/EC as amended (Machinery Directive)	EN 1050 hazard analysis CD 77/311/EEC driver-perceived noise level	
2004/108/EC as amended (EMC Directive)	CISPR 12:2001 CAN/CSA-C108.4-M92	EN 55012:2002 EN 61000-6-2:2001

## PRODUCT IDENTIFICATION

VEHICLE SERIES	TRADE NAME	MODEL YEARS	SOUND PRESSURE dB (A)
KA05	OUTLAW 50	2008, 2009, 2010	76.8
KA09	OUTLAW 90	2008, 2009, 2010	76.8
FA09	SPORTSMAN 90	2008, 2009, 2010	76.8
VA17	RZR 170	2009, 2010	81.3
PB20	PHOENIX 200	2008, 2009, 2010	76.8
BA32	TRAIL BLAZER 330	2008, 2009, 2010	76.8
CA32	TRAIL BOSS 330	2008, 2009, 2010	76.8
BA50	SCRAMBLER 500	2008, 2009, 2010	79.6
GJ45	OUTLAW 450	2008, 2009, 2010	80.7
GJ52 , GP52	OUTLAW 525	2008, 2009, 2010	80.7
LH27	SPORTSMAN 300	2008, 2009, 2010	81.1
LH46	SPORTSMAN 400	2008, 2009, 2010	80.2
MN50	SPORTSMAN 500 EFI	2008, 2009, 2010	80.4
ZN55 ZX55	SPORTSMAN 550 EFI	2009, 2010	80.8
TN55 , DN55	SPORTSMAN X2/TOURING 550	2010	77.2
MN76	SPORTSMAN 800	2008, 2009, 2010	83.6
TN85 , DN85	SPORTSMAN X2/TOURING 850	2010	77.2
CL76	SPORTSMAN 800 6X6	2009, 2010	80.1
ZN85 , ZX85	SPORTSMAN 850 EFI	2009, 2010	80.4
RH50 , HH50	RANGER 500 EFI 4X4	2009, 2010	76.5
HH76	RANGER 800 EFI 4X4	2010	76.5
WH76	RANGER 800 EFI CREW	2010	76.5
HR	RANGER 800 6X6	2010	76.5
HY	RANGER HD 800 4X4	2010	76.5
VH76	RANGER RZR	2008, 2009, 2010	85.8

Authorized Signatory:

Alexander A. Kennedy, Product Compliance  
Polaris Industries Inc., Engineering Operations  
301 5th Avenue SW, Roseau, MN 56751

# WARRANTY

## LIMITED WARRANTY

Polaris Sales Inc., 2100 Highway 55, Medina, MN 55340, gives a SIX MONTH LIMITED WARRANTY on all components of the Polaris All Terrain Vehicle (ATV) against defects in material or workmanship. Polaris also gives a one year limited warranty on the final drive chain for failure due to defects. This warranty covers the parts and labor charges for repair or replacement of defective parts which are covered by this warranty. This warranty begins on the date of purchase. This warranty is transferable to another consumer during the warranty period through a Polaris dealer.

## REGISTRATION

At the time of sale, the Warranty Registration Form must be completed by your dealer and submitted to Polaris within ten days. Upon receipt of this registration, Polaris will record the registration for warranty. No verification of registration will be sent to the purchaser as the copy of the Warranty Registration Form will be the warranty entitlement. If you have not signed the original registration and received the customer copy, please contact your dealer immediately. **NO WARRANTY COVERAGE WILL BE ALLOWED UNLESS YOUR ATV IS REGISTERED WITH POLARIS.**

Initial dealer preparation and set-up of your ATV is very important in ensuring trouble-free operation. Purchasing a machine in the crate or without proper dealer set-up will void your warranty coverage.

# WARRANTY

## WARRANTY COVERAGE AND EXCLUSIONS: LIMITATIONS OF WARRANTIES AND REMEDIES

The Polaris limited warranty excludes any failures that are not caused by a defect in material or workmanship. This warranty does not cover accidental damage, normal wear and tear, abuse or improper handling. This warranty also does not cover any ATV that has been altered structurally, modified, neglected, improperly maintained, used for racing, or used for purposes other than for which it was manufactured, or for any damages which occur during trailer transit or as a result of unauthorized service or the use of unauthorized parts. In addition, this warranty does not cover physical damage to paint or finish, stress cracks, tearing or puncturing of upholstery material, corrosion, or defects in parts, components or the ATV due to fire, explosions or any other cause beyond Polaris' control.

Warranty does not apply to parts exposed to friction surfaces, stresses, environmental conditions and/or contamination for which they were not designed or not intended, including but not limited to the following items:

- Wheels and tires
- Suspension components
- Brake components
- Seat components
- Clutches and components
- Steering components
- Batteries
- Light bulbs/Sealed beam lamps
- Finished and unfinished surfaces
- Carburetor/Throttle body components
- Engine components
- Drive belts
- Hydraulic components
- Circuit breakers/Fuses
- Electronic components

Warranty applies to the product only and does not allow for coverage of personal loss. Some items are considered "consumable," meaning they are considered part of normal maintenance or part of completing an effective repair. The following items are excluded from warranty coverage in the event of a warranty claim:

- Spark Plugs
- Filters
- Fuel
- Sealants
- Hotel fees
- Towing charges
- Mileage
- Rentals/Loss of product use
- Lubricants such as oil, grease, etc.
- Batteries (unless defective)
- Cosmetic damage/repair
- Coolants
- Meals
- Shipping/ handling fees
- Product pick-up/delivery
- Loss of vacation/personal time

# WARRANTY

## LIMITATIONS OF WARRANTIES AND REMEDIES

This warranty also excludes failures resulting from improper lubrication; improper engine timing; improper fuel; surface imperfections caused by external stress, heat, cold or contamination; operator error or abuse; improper component alignment, tension, adjustment or altitude compensation; failure due to snow, water, dirt or other foreign substance ingestion/contamination; improper maintenance; modified components; use of aftermarket components resulting in failure; unauthorized repairs; repairs made after the warranty period expires or by an unauthorized repair center; use of the product in competition or for commercial purposes. Warranty will not apply to any product which has been damaged by abuse, accident, fire or any other casualty not determined a defect of materials or workmanship.

This warranty does not cover the use of unauthorized lubricants, chemicals, or fuels that are not compatible with the ATV. The exclusive remedy for breach of this warranty shall be, at Polaris' exclusive option, repair or replacement of any defective materials, or components or products. THE REMEDIES SET FORTH IN THIS WARRANTY ARE THE ONLY REMEDIES AVAILABLE TO ANY PERSON FOR BREACH OF THIS WARRANTY. POLARIS SHALL HAVE NO LIABILITY TO ANY PERSON FOR INCIDENTAL, CONSEQUENTIAL OR SPECIAL DAMAGES OF ANY DESCRIPTION, WHETHER ARISING OUT OF EXPRESS OR IMPLIED WARRANTY OR ANY OTHER CONTRACT, NEGLIGENCE, OR OTHER TORT OR OTHERWISE. Some states do not permit the exclusion or limitation of incidental or consequential damages or implied warranties, so the above limitations or exclusions may not apply to you if inconsistent with controlling state law.

# WARRANTY

ALL IMPLIED WARRANTIES (INCLUDING BUT NOT LIMITED TO THE IMPLIED WARRANTIES OF MERCHANTABILITY AND FITNESS FOR A PARTICULAR PURPOSE) ARE LIMITED IN DURATION TO THE ABOVE SIX MONTH WARRANTY PERIOD. POLARIS FURTHER DISCLAIMS ALL EXPRESS WARRANTIES NOT STATED IN THIS WARRANTY. Some states do not allow limitations on how long an implied warranty lasts, so the above limitation may not apply to you if inconsistent with controlling state law.

## HOW TO OBTAIN WARRANTY SERVICE

If your ATV requires warranty service, you must take it to a Polaris dealer authorized to repair Polaris ATVs. When requesting warranty service you must present your copy of the Warranty Registration form to the dealer. (THE COST OF TRANSPORTATION TO AND FROM THE DEALER IS YOUR RESPONSIBILITY). Polaris suggests that you use your original selling dealer; however, you may use any Polaris Servicing Dealer to perform warranty service.

Please work with your dealer to resolve any warranty issues. Should your dealer require any additional assistance they will contact the appropriate person at Polaris.

This warranty gives you specific legal rights, and you may also have other rights which vary from state to state.

If any of the above terms are void because of state or federal law, all other warranty terms will remain in effect.

## Engine Oil

1. Mixing oil brands or using non-recommended oil may cause engine damage. We recommend the use of Polaris engine oil for your ATV.
2. Damage resulting from the use of non-recommended lubricants may not be covered by warranty.

## SPARK ARRESTOR

Polaris warrants that the spark arrestor in this vehicle will meet the efficiency requirements of USFS standard 5100-1c for at least 1000 hours when subjected to normal use and when maintenance and installation are in accordance with Polaris recommendations.



## Exported Vehicles

EXCEPT WHERE SPECIFICALLY REQUIRED BY LAW, THERE IS NO WARRANTY OR SERVICE BULLETIN COVERAGE ON THIS VEHICLE IF IT IS SOLD OUTSIDE THE COUNTRY OF THE SELLING DEALER'S AUTHORIZED LOCATION.

This policy does not apply to vehicles that have received authorization for export from Polaris Industries. Dealers may not give authorization for export. You should consult an authorized dealer to determine this vehicle's warranty or service bulletin coverage if you have any questions.

This policy does not apply to vehicles registered to government officials or military personnel on assignment outside the country of the selling dealer's authorized location.

This policy does not apply to Safety Recalls.

## How to Get Service

### *In the Country where your vehicle was purchased:*

Warranty or Service Bulletin repairs must be done by an authorized Polaris dealer. If you move or are traveling within the country where your vehicle was purchased, Warranty or Service Bulletin repairs may be requested from any authorized Polaris dealer who sells the same line as your vehicle.

### *Outside the Country where your vehicle was purchased:*

If you are traveling temporarily outside the country where your vehicle was purchased, you should take your vehicle to an authorized Polaris dealer. You must show the dealer photo identification from the country of the selling dealer's authorized location as proof of residence. Upon residence verification, the servicing dealer will be authorized to perform the warranty repair.

### *If You Move:*

If you move to another country, be sure to contact Polaris Customer Assistance and the customs department of the destination country before you move. Vehicles importation rules vary considerably from country to country. You may be required to present documentation of your move to Polaris Industries in order to continue your warranty coverage. You may also be required to obtain documentation from Polaris Industries in order to register your vehicle in your new country.

# WARRANTY

## Exported Vehicles

### How to Get Service

#### *If Purchased From A Private Party:*

If you purchase a Polaris product from a private citizen, to be kept and used outside of the country in which the vehicle was originally purchased, all warranty coverage will be denied.

### Notice

If your vehicle is registered outside of the country where it was purchased, and you have not followed the procedure set out above, your vehicle will no longer be eligible for warranty or service bulletin coverage of any kind. (Vehicles registered to Government officials or military personnel on assignment outside of the country where the vehicle was purchased will continue to be covered by the basic warranty.)

#### *For questions call Polaris Customer Assistance:*

United States: 1-888-704-5290

Canada: 1-204-925-7100

# WARRANTY

## U.S.A. EPA Emissions Limited Warranty

This emissions limited warranty is in addition to the Polaris standard limited warranty for your vehicle. Polaris Industries Inc. warrants that at the time it is first purchased, this emissions-certified vehicle is designed, built and equipped so it conforms with applicable U.S. Environmental Protection Agency emission regulations. Polaris warrants that the vehicle is free from defects in materials and workmanship that would cause it to fail to meet these regulations.

The warranty period for this emissions-certified vehicle starts on the date the vehicle is first purchased and continues for a period of 500 hours of engine operation, 5000 kilometers (3100 miles) of vehicle travel, or 30 calendar months from the date of purchase, whichever comes first.

This emissions limited warranty covers components whose failure increases the vehicle's regulated emissions, and it covers components of systems whose only purpose is to control emissions. Repairing or replacing other components not covered by this warranty is the responsibility of the vehicle owner. This emissions limited warranty does not cover components whose failure does not increase the vehicle's regulated emissions.

For exhaust emissions, emission-related components include any engine parts related to the following systems:

- Air-induction system
- Fuel system
- Ignition system
- Exhaust gas recirculation systems

The following parts are also considered emission-related components for exhaust emissions:

- Aftertreatment devices
- Crankcase ventilation valves
- Sensors
- Electronic control units

The following parts are considered emission-related components for evaporative emissions:

- Fuel Tank
- Fuel Cap
- Fuel Line
- Fuel Line Fittings
- Clamps\*
- Pressure Relief Valves\*
- Control Valves\*
- Control Solenoids\*
- Electronic Controls\*
- Vacuum Control Diaphragms\*
- Control Cables\*
- Control Linkages\*
- Purge Valves
- Vapor Hoses
- Liquid/Vapor Separator
- Carbon Canister
- Canister Mounting Brackets
- Carburetor Purge Port Connector

\*As related to the evaporative emission control system.

# WARRANTY

## U.S.A. EPA Emissions Limited Warranty

The exclusive remedy for breach of this limited warranty shall be, at the exclusive option of Polaris, repair or replacement of any defective materials, components or products. THE REMEDIES SET FORTH IN THIS LIMITED WARRANTY ARE THE ONLY REMEDIES AVAILABLE TO ANY PERSON FOR BREACH OF THIS WARRANTY. POLARIS SHALL HAVE NO LIABILITY TO ANY PERSON FOR INCIDENTAL, CONSEQUENTIAL OR SPECIAL DAMAGES OF ANY DESCRIPTION, WHETHER ARISING OUT OF EXPRESS OR IMPLIED WARRANTY OR ANY OTHER CONTRACT, NEGLIGENCE OR OTHER TORT OR OTHERWISE.

ALL IMPLIED WARRANTIES (INCLUDING BUT NOT LIMITED TO ANY IMPLIED WARRANTIES OF MERCHANTABILITY AND FITNESS FOR A PARTICULAR PURPOSE) ARE LIMITED IN DURATION TO THE WARRANTY PERIOD DESCRIBED HEREIN. POLARIS DISCLAIMS ALL EXPRESS WARRANTIES NOT STATED IN THIS WARRANTY. Some states do not allow limitations on how long an implied warranty lasts, so the above limitation may not apply if it is inconsistent with the controlling state law.

This limited warranty excludes failures not caused by a defect in material or workmanship. This limited warranty does not cover damage due to accidents, abuse or improper handling, maintenance or use. This limited warranty also does not cover any engine that has been structurally altered, or when the vehicle has been used in racing competition. This limited warranty also does not cover physical damage, corrosion or defects caused by fire, explosions or other similar causes beyond the control of Polaris.

Owners are responsible for performing the scheduled maintenance identified in the owner's manual. Polaris may deny warranty claims for failures that have been caused by the owner's or operator's improper maintenance or use, by accidents for which Polaris has no responsibility, or by acts of God.

Any qualified repair shop or person may maintain, replace, or repair the emission control devices or systems on your vehicle. Polaris recommends that you contact an authorized Polaris dealer to perform any service that may be necessary for your vehicle. Polaris also recommends that you use only Pure Polaris parts. It is a potential violation of the Clean Air Act if a part supplied by an aftermarket parts manufacturer reduces the effectiveness of the vehicle's emission controls. Tampering with emission controls is prohibited by federal law.

If you have any questions regarding your warranty rights and responsibilities, please contact the Polaris Warranty Department at 1-888-704-5290.





# INDEX

## A

Accessories . . . . .	111
Air Filter . . . . .	83
All Wheel Drive System . . . . .	33
Apparel, Protective . . . . .	12
Auxiliary Foot Brake . . . . .	78
AWD Switch . . . . .	24, 33
AWD System . . . . .	33

## B

<b>Battery . . . . .</b>	<b>97-102</b>
Charging (Conventional) . . . . .	101
Charging (Sealed) . . . . .	101-102
Fluid (Conventional) . . . . .	100
Installation . . . . .	99
Removal . . . . .	98
Storage . . . . .	100
Belt Life . . . . .	32
Boots . . . . .	9
Brake Fluid, Auxiliary Foot Brake . . . . .	30
Brake Fluid, Main Brake System . . . . .	28
Brake Lever . . . . .	27
Brake, Foot . . . . .	30, 78
Brake, Hand Lever . . . . .	78
Brake, Parking . . . . .	29
Brakelight Lamp Replacement . . . . .	89
Brakes . . . . .	78
Break-In Period . . . . .	41-42
Breather Filter . . . . .	84
Breather Hose . . . . .	84

## C

Camber Adjustment . . . . .	103
Carburetor . . . . .	104
Carburetor Adjustment . . . . .	104
Cargo . . . . .	58-59
Caster Adjustment . . . . .	103
Choke . . . . .	31
Chrome Wheel Care . . . . .	108
Cleaning and Storage . . . . .	106-111
Clothing . . . . .	9
Clutching Chart . . . . .	119
Consumer Product Safety . . . . .	7

## C

Coolant Bottle . . . . .	76
Coolant, Radiator . . . . .	77
Cooling System . . . . .	76-77
Corrosion Removal, Chrome . . . . .	108
Crankcase Emission Control System . . . . .	61

## D

Demand Drive Capacities . . . . .	74
Drive Belt Wear/Burn . . . . .	113
Drivetrain Break-In . . . . .	42
Driving Downhill . . . . .	53
Driving in Reverse . . . . .	57
Driving on a Sidehill . . . . .	52
Driving on Slippery Surfaces . . . . .	50
Driving Over Obstacles . . . . .	56
Driving Procedures . . . . .	48
Driving Through Water . . . . .	55
Driving Uphill . . . . .	51

## E

Electromagnetic Interference . . . . .	61
Emissions Limited Warranty . . . . .	127-128
Engaging AWD . . . . .	33
Engine Break-In . . . . .	42
Engine Fogging . . . . .	110
Engine Idle RPM Adjustment . . . . .	104
Engine Oil . . . . .	68-69
Equipment Modifications . . . . .	9
Etiquette, Trail Riding . . . . .	44
Exhaust Emission Control System . . . . .	61
Eye Protection . . . . .	9

## F

Fluid, Brake . . . . .	28, 30
Fluid, Demand Drive . . . . .	74-75
Fluid Change, Demand Drive . . . . .	75
Foot Brake, Auxiliary . . . . .	30
Footwell Removal . . . . .	80
Fuel Filter . . . . .	31
Fuel Recommendations . . . . .	31
Fuel Safety . . . . .	11
Fuel Tank Cap . . . . .	31

# INDEX

<b>F</b>	
Fuel Valve .....	31
Fuse Replacement .....	85

<b>G</b>	
Gasoline Handling .....	11
Gear Selector .....	32
Gloves .....	9

<b>H</b>	
Hand Brake .....	78
Handlebar Adjustment .....	103
Hauling Cargo .....	58-59
Headlight Housing Replacement .....	88
Headlight Lamp Replacement .....	86
Headlight Switch .....	25
Helmet .....	8
High Beam Adjustment .....	87
High Range Use .....	96

<b>I</b>	
Idle RPM Adjustment .....	104
Immersion Maintenance .....	92
Instrument Cluster .....	34-40

<b>J</b>	
Jetting Chart .....	119

<b>K</b>	
Key Switch .....	25
K-Turn .....	54

<b>L</b>	
<b>Lights</b> .....	<b>86-89</b>
Headlight Housing Replacement .....	88
Headlight Lamp .....	86
High Beam Adjustment .....	87
Low Beam Adjustment .....	87
Lower Headlamp Replacement .....	89
Taillight/Brakelight .....	89
Low Beam Adjustment .....	87

<b>L</b>	
Low Range Use .....	96
Lower Headlamp Replacement .....	89
Lubrication Guide .....	67

<b>M</b>	
Maintenance Chart .....	62-66
Master Cylinder .....	28
Mode Switch .....	24
Modifications .....	9

<b>N</b>	
Noise Emission Control System .....	61

<b>O</b>	
Oil, Engine .....	68-69
Oil, Transmission .....	73-74
Oil and Filter Change .....	70-72
Oil Level, Engine .....	69
Oil Pump Priming .....	72
Oil Recommendations .....	68
Operation on Public Lands .....	61
Override Switch .....	24

<b>P</b>	
Parking Brake .....	29
Parking on an Incline .....	60
Periodic Maintenance Chart .....	62-66
Polaris Product List .....	117
Polishing the Vehicle .....	107
Pre-Ride Checklist .....	45
PVT Break-In .....	42
PVT Drying .....	96
PVT System .....	94-96

<b>R</b>	
Reverse Operation .....	57
Reverse Override Switch .....	24
Rider Information Center .....	35-40
Riding Area .....	44
Riding Gear .....	8-9



# INDEX

## S

Safe Operation Practices	43
Safety Decals	21-23
<b>Safety Labels</b>	
"No Passenger" Warning	22
Age 16 Warning	22
Clutch Cover Warning	23
Discretionary Warning	21
General Warning	21
Rack Warning, Front and Rear	23
Reverse Override Warning	23
Tire Pressure/Load Warning	22
Safety Training	7
Safety Warnings	10-20
Service Interval Programming	39
Severe Use	62
Side Panel Removal	80
Sidehilling	52
Signal Words	4
Spark Arrestor	93
Spark Plug Inspection	90-91
Spark Plug Recommendations	90
Spark Plug Torque Specification	90
Spark Plugs	90-91
Specifications	118-119
Spring Adjustment, Rear Shock	103
Starting the Engine	46-47
Steering Assembly	80
Storage	106-111
Storage Tips	109-111
<b>Switches</b>	
AWD Switch	24, 33
Engine Stop Switch	25
Headlight Switch	25
Main Key Switch	25
Mode/Reverse Override Switch	24

## T

Taillight Lamp Replacement	89
Throttle Cable Freeplay Adjustment	105
Throttle Lever	26
Tire Tread Depth	81
<b>Tires</b>	<b>81-82</b>
Wheel Installation	82
Wheel Nut Torque	82
Wheel Removal	81
Toe Alignment	79
Towing Loads	59
Trail Etiquette	44
Training	7
Transmission	32
Transmission Oil	73-74
Transporting the ATV	112
Tread Lightly	44
Turning Around on a Hill	54
Turning the Vehicle	49

## V

Vehicle Identification Numbers	6
Vehicle Immersion	92
VIN	6

## W

Warning Symbols	4
Washing the Vehicle	106-107
Wheel Hub Tightening	81
Wheel Installation	82
Wheel Nut Torque Specifications	82
Wheel Removal	81